

## Radio Horizons

WHEN Heinrich Hertz confirmed experimentally the mathematical predictions of Clerk Maxwell that electromagnetic waves could be generated and would be propagated with the speed of light he was too preoccupied with the physics of the phenomenon to give much thought to the possible application of cause and effect across the width of a room to the transmission and reception of messages over greater distances. It was left to others to develop the possibilities of this new knowledge and in particular to pioneers like Henry Jackson and Marconi whose vision and persistence were strong enough to break through the contemporary restrictions of inadequate techniques and official scepticism.

Once the first few yards had been extended to miles, the course of future development seemed clear. All that remained was to increase transmitter power and to improve receiver sensitivity. But before ranges had reached hundreds of miles the curvature of the earth's surface appeared as a possible limiting factor. It was once again the persistence of Marconi which cut through all pessimistic arguments and successfully sent a signal from Cornwall to Newfoundland in 1901. Yet another triumph of practice over precept was scored in 1920 by American and British amateurs in spanning the Atlantic on the "useless" short wavelengths of 200 metres or so; this several years before Appleton had established the existence and started to explore the exact nature of the ionosphere.

In the years since 1924 the ionosphere has been the subject of intensive study by means of continuous-wave and pulsed reflections from ground-based stations and the results form the basis of precise forecasting of optimum frequencies and paths of transmission for economical point-to-point radio communications over the whole surface of the globe. The work of the I.G.Y. has considerably extended this study, particularly near the magnetic poles, and the early results, reported elsewhere in this issue, show that the possibilities of conventional sounding techniques are by no means exhausted. But from the scientific point of view they have one serious limitation, namely, that while they give information of the underside of the laminated ionospheric "mirror" they cannot tell us anything about the backing. Signals of frequencies capable of penetrating the ionosphere are either lost in space or, if they are reflected from the moon or if signals originating from satellites are used, they can give only the total electron content of the intervening space. This has proved to be many times greater than the known numbers below the F layer, a fact which suggests a much further extension of the earth's atmosphere (or alternatively of the sun's atmosphere) than had hitherto been supposed. The whistling atmospherics investigated by L. R. O.

Storey\* led to the conclusion that atmospheric conduction extended to a height equivalent to at least two earth radii, and the recent discovery by van Allen and his colleagues of radiation belts at distances up to seven or eight earth radii now confirms the extent and complexity of the earth's immediate environment.

Although these discoveries may have little impact on day-to-day terrestrial radio communications they will be of great interest to radio astronomers, for it is through the window of the earth's atmosphere that they must receive their signals from the limits of the universe. A detailed knowledge of the structure of the window and of possible aberrations is vital. The bandwidths of the visual and radio "holes" in the transmission spectrum of the atmosphere are relatively narrow and the electromagnetic information which penetrates to the earth's surface is often blurred by scintillation. Optical observatories are sited on mountain tops to get as far as possible above thermal turbulence, and it has been suggested that future radio observatories working on frequencies above 30 kMc/s and below 1 Mc/s would have to be mounted on satellites and other space vehicles. It now seems likely that they will have to travel much further than was at first thought necessary in order to get a clear "view."

All this has some bearing too on the possibility of interplanetary communication with civilizations in other solar systems, a topic much discussed recently and the subject of a note on page 87 of this issue. Knowing the diversity of planetary atmospheres in our own solar system we must hope that the radio "windows" of other planets supporting intelligent life will coincide with or overlap our own at least to the extent of including the 21-cm hydrogen line.

That interplanetary communication between different solar systems can be now seriously considered is due in large measure to the novel methods of amplification such as masers and mavarst† (parametric amplifiers) which do not depend primarily on electronic emission currents with their discrete and random noise generating properties. This is a landmark in receiving technique comparable with the change from wiring to "plumbing" and the transfer of energy in confined fields rather than as currents in conductors.

We have travelled a long way since Hertz, and the history of our progressive extension of the range of radio communication is punctuated by successive "break-throughs" in our knowledge, not only of the techniques of generating and receiving signals, but of the medium through which they are propagated.

\* See *Wireless World* July 1953, p. 338.

† See *Wireless World* April 1959, p. 197, and May 1959, p. 242.

# RADIO AND THE I.G.Y.

By R. L. SMITH-ROSE,\* C.B.E., D.Sc., Ph.D., F.C.G.I., M.I.E.E.

**T**HE International Geophysical Year denotes the period 1st July, 1957, to 31st December, 1958, during which the scientists of some 66 nations worked at over 4,000 observatories throughout the world on a co-operative programme concerned with the physical properties of the earth and its atmosphere, and with the related solar and terrestrial phenomena. As described in an earlier article,<sup>1</sup> the I.G.Y. was the direct descendant of two earlier enterprises known as the First and Second International Polar Years which took place in 1882-83 and 1932-33 respectively. In the second of these, radio was used for the first time to study the characteristics of the ionosphere in Arctic regions; and as it happens, this took place during a period of minimum sunspot activity, whereas the I.G.Y. was conducted 25 years later during what turned out to be an epoch of the highest solar activity for the past 200 years.

In addition to a calendar of observation days drawn up in advance, provision was made during the progress of the I.G.Y. for the declaration of Special World Intervals when the state of the sun indicated the likelihood of a geophysical disturbance which might affect, for example, the ionosphere, and the earth's magnetic field. For this purpose an international network of radio and line communications was used to alert all participating observers and warn them that such a S.W.I. might, subject to confirmation, begin sixteen hours later. During the I.G.Y. 44 such alerts took place; of these, 22 culminated in a Special World Interval, during 17 of which, major solar and terrestrial disturbances occurred. In addition, there were 6 severe and 33 mild disturbances for which no previous warning or alert had been issued.

Provision was also made in advance for the setting up of a number of World Data Centres. The two main centres in U.S.A. and U.S.S.R. collect data relating to all disciplines in the programme; while in the radio field two additional centres in England and Japan were set up. The former is at the D.S.I.R. Radio Research Station at Slough, where, up to date, over a million sheets of ionospheric records and results, together with atmospheric noise and auroral data, have been received. It is likely that the mass of material brought together in this way will provide the basis of research in geophysics for many years to come, and in this brief review it is possible to refer to only one or two examples of the results which have already been achieved.

## Physics of the Lower Atmosphere

The first International Polar Year, 1882-83, arose from the desire of meteorologists to know more about the physical characteristics of the atmosphere in the less accessible places. This applied particularly to the regions of the north and south poles,

as it was considered that a knowledge of atmospheric conditions in these areas would lead to a better understanding of the factors which determine weather and the climate of the world. Today the network of meteorological observatories provides the basis of what is probably the most detailed international scientific organization throughout the world. Under the auspices of the World Meteorological Organization, with its comprehensive radio and line communications system, a very rapid reporting system has been developed which provides the most up-to-date weather and forecasting information for the needs of the whole world.

The primary aim of the meteorological programme for the I.G.Y. was to obtain a more nearly complete global picture of the mechanism of the general circulation in the atmosphere and its smaller-scale systems. To this end special stations were established in the polar regions, equatorial areas and on oceanic islands to supplement the observations made at permanent stations. Efforts were made at aerological stations to extend radio-sonde measurements to greater heights—to about 30 km where practicable—and to make more frequent soundings during the World Meteorological Intervals and on other World Days. Special mention should perhaps be made of the great expansion of observational facilities in the Antarctic. Some 50 stations made surface weather observations at least four times each day: added to this there were twice-daily upper-air soundings at 16 stations to an average height of about 20 km. For the first time in history it has now been possible to construct charts showing broad circulation patterns at various atmospheric levels above the Antarctic.

**Thunderstorms and Atmospheric Radio Noise.**—For many years past, the meteorologist has used a network of radio direction-finding stations to locate the existence and movement of thunderstorms which make themselves evident by the emission of radio waves from lightning flashes. Having provided this kind of tool to the meteorologist, the radio scientist is further interested in obtaining measurements of the intensity and structure of the waves comprising atmospheric noise, which can so disturb radio reception in various parts of the world. As a result of past work involving international co-operation, tentative charts<sup>2</sup> have been produced indicating the order of magnitude, and probable frequency of occurrence, of the atmospheric radio noise likely to be encountered at different seasons throughout the world.

The main objective of the I.G.Y. noise programme has been the establishment of a network of stations for the measurement of a specific characteristic of the atmospheric noise received from lightning flashes. The characteristic chosen was the received noise power, averaged over a period of about an hour. The measurement of various parameters, including the noise power which is related to the r.m.s field strength, was made at 13 stations during the I.G.Y. At a few of these the observations were made by

\* Director of Radio Research, Department of Scientific and Industrial Research.

# COLLECTION OF DATA : METHODS OF ANALYSIS : NEW KNOWLEDGE OF THE IONOSPHERE AND OF OUTER SPACE

both manual and automatic recording methods, and some apparent discrepancies between the two sets of results are under investigation. A third method, which has been in use for many years at 15 stations in different parts of the world, was continued during the I.G.Y. In this, the strength of a locally generated signal is determined which is just sufficient to be intelligible through the noise.

Other I.G.Y. projects were designed to study the nature of the noise as it is radiated by the source—the lightning flashes—and the manner in which it is modified as it is propagated through the atmosphere. Records of the noise near to the source have been made, at several frequencies, on magnetic tape, and are being analysed to determine their energy, and other characteristics. Fig. 1 shows a record of atmospherics recorded at the D.S.I.R. Radio Research Station, Slough, on two frequencies, from a flash which struck the ground half a mile away. The upper record shows characteristic large impulses at 6 kc/s, from the ground strokes, and the more complex nature of the records at 11 Mc/s. Reproduction of the records at higher gain shown below, reveals that the atmospherics are more complex than first appeared even at 6 kc/s. Many of the features of these records cannot be readily explained on present theories of the lightning discharge.

As an example of the studies of the effects of propagation, low-frequency atmospherics from the same lightning flash were recorded at several stations in Europe; and comparisons are now in progress to examine how their form changes with the distance, and possibly with the direction of propagation.

## Study of the Ionosphere

The exploration of the ionosphere by vertical soundings using pulse techniques was established on a regular basis in the U.K. and U.S.A. over 25 years ago. Only two or three stations were working during the second International Polar Year, but some 80 were in regular operation before the I.G.Y. began, and about twice this number were established during the I.G.Y. The work of these stations has produced

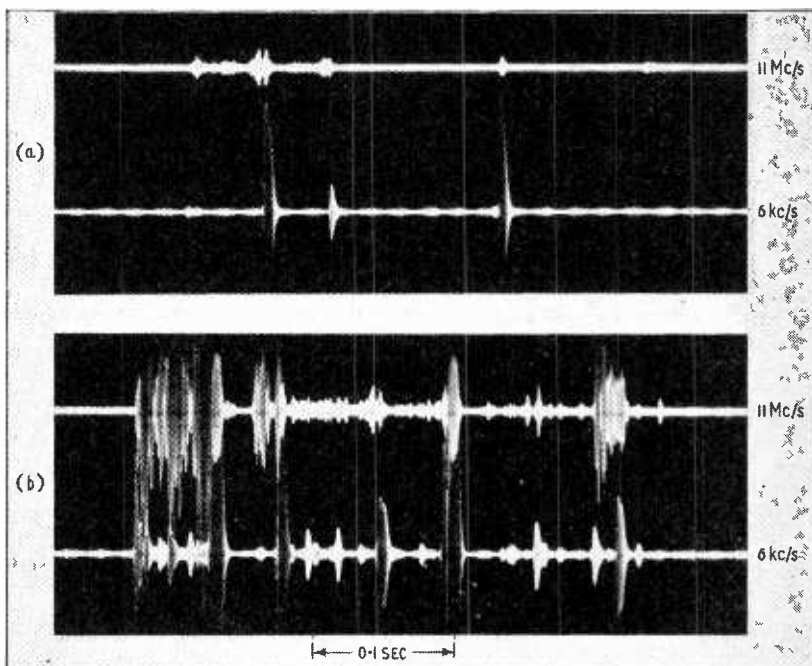

Fig. 1. Waveform of atmospherics from a very near lightning flash. Peak amplitudes 1.4mV/m at 11 Mc/s, 3.5 V/m at 6kc/s

over one million tables of measurements and photographic records which refer to the period of the I.G.Y. The study and assimilation of this vast accumulation of data will take many years; but to illustrate how some of these data have already been used, two examples may be referred to here. One of these deals with small quantities of data which have been examined in great detail and very accurately: the other is concerned with the approximate statistical treatment of a large amount of data referring to specific ionospheric characteristics.

**Distribution of Ionization and M.U.Fs.**—The calculation of maximum usable frequencies (M.U.F.) for radio communication circuits is based on the assumption that the electron density in the F2 layer increases with height according to a parabolic law. The refractive properties of a non-parabolic layer might be expected to lead to maximum usable frequencies above or below those at present in use. Now it is arduous to derive the actual distribution of electron density from the observational records by manual methods. During the I.G.Y., first in the United Kingdom and later in other countries, digital computers have been programmed to calculate these distributions of electron density with height on a routine basis. These distributions are termed  $N(h)$  profiles, and they are often found in practice to be far from parabolic in form. By tracing the ray-paths through ionized layers conforming with the

measured profiles, it has been shown that, although the actual M.U.F. factors do not differ by an appreciable amount from those calculated assuming a single parabolic F2 layer, the angle of arrival of the waves for a given distance between the transmitter and receiver tends to be greater than that for a parabolic layer of the type usually assumed. Thus the practical conclusions reached are that while the maximum usable frequencies now in use are not seriously affected by the shape of the layer, it may be desirable to use aerial systems which project the radiation at a greater angle of elevation than has hitherto been considered the most appropriate.

**Solar-Cycle Changes in  $f_oF_2$ .**—In the previous example, the whole of the observational data for about ten ionograms have been studied in very great detail. The next example deals with the critical frequency of the F2 region using data obtained from many thousands of ionograms from all parts of the world.

During the I.G.Y., solar activity was considerably higher than it has been since regular visual observations of the number and magnitude of sunspots were begun about 200 years ago. As a consequence, the ionization and hence the critical frequencies of the ionospheric layers have reached unprecedented high levels as illustrated in Fig. 2 which shows the critical frequencies observed at the Radio Research Station, Slough, during the past 27 years. This new information on ionospheric behaviour at very high solar activity is unique and is unlikely to be repeated for many years to come. This is important because it adds a great deal to earlier knowledge on the relations between solar activity and critical frequencies, an understanding of which is essential to the accurate forecasting of M.U.F.s for communications.

**Drifts.**—The normal methods of sounding the ionosphere pay no attention to the fact that the reflecting layers are not at rest, but appear to be moving with horizontal velocities which vary with the height of reflexion. Special techniques are required for the measurement of these velocities and these have only been developed in the last decade to a stage where they can be used with some con-

fidence. Although only 20 to 30 observatories undertook measurements of ionospheric drifts during the I.G.Y., the information already available has given results which tend to fall in to a consistent pattern.

The drifts of ionization follow a diurnal variation; for example, at Ibadan in Nigeria, the prevailing directions are to the west by day and to the east by night at all seasons. It was also found that on magnetically disturbed days the drifts are less pronounced than on the quiet days. At the more temperate latitude of Cambridge, there is also a marked north-south component in the drift velocity. This has been found to have a long term variation related to the solar cycle; at the period of maximum activity the drift was towards the equator, whereas at the epoch of minimum activity the direction was reversed. It is likely also that the vertical movement was subject to similar changes in direction.

It is becoming increasingly evident that in some parts of the world the vertical and horizontal movements of clouds of ionization play an important part in determining the characteristics of the ionosphere, which are not simply related in time to the locally incident radiation from the sun.

### Ionospheric Investigation in the Antarctic

The I.G.Y. provided the impetus for a scientific survey of Antarctic and Arctic ionospheric conditions on a scale which had not previously been attempted. In the Antarctic, British ionospheric stations were operated by the Royal Society, at Halley Bay in the Weddell Sea, and by the Falkland Islands Dependencies Survey, at Port Lockroy in Grahamland. Other stations were operated by France, U.S.S.R., and other countries, including one at the South Pole where the U.S.A. had a large base.

The Jodrell Bank radio astronomy observatory made a continuous survey of auroral and meteor activity in co-operation with Halley Bay throughout the I.G.Y. Preliminary results have already shown that radio echo auroral activity at Jodrell Bank corresponds to the peaks in activity at Halley Bay. The incidence of meteors was observed by the range of reflection of radio echoes produced by the trails

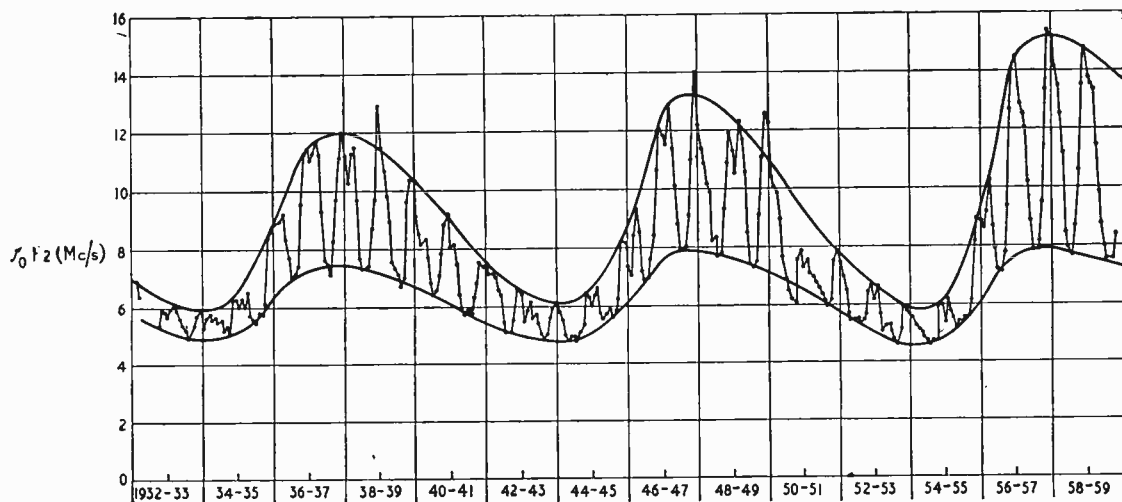

Fig. 2. Measured noon values of  $f_oF_2$  at Slough, 1932-1959

of ionization left behind the meteors as they burnt up in the atmosphere. Drifts of ionization were measured at heights of 85 to 105 km; the resulting pattern of these drifts or "winds" in the ionosphere was found to be very regular, unlike the winds at the surface of the earth. The speeds of these ionospheric drifts are about 100 miles per hour\*, and their directional vector rotates clockwise twice each day. They are towards the north at 6.0 a.m., to the east at 9.0 a.m., south at noon, west at 3.0 p.m., and so to the north again at 6.0 p.m. local time. This regular behaviour is due to tidal and heating effects of the sun in the upper atmosphere, which cause the atmosphere to expand and contract twice per solar day in the same way that the moon causes the seas to rise and fall twice each lunar day.

Ionospheric observations made at high latitudes have a special significance; and the complicated behaviour of the F layer in the Antarctic may be clarified considerably by attempting to separate those phenomena due to electrons produced by the sun's radiation on the upper atmosphere from those due to horizontal or vertical movements of electrons from other locations.

Movements of ionospheric layers are almost entirely generated by electrical forces interacting with the earth's permanent magnetic field; and the velocity of the movement therefore depends on the direction of this field, and, in particular, on the angle of dip. The interpretation of detailed studies of a layer thus depends on the magnetic dip in the ionosphere above the sounding station. There is a unique dip anomaly in the Weddell Sea area due to the asymmetry of the magnetic field in relation to the centre of the earth. This anomaly is so great that the dip angle at the Royal Society Base at Halley Bay, 75° S, is the same as that at Canberra, 35° S, or at similar latitudes in Florida in the northern hemisphere. As a result the interpretations of ionospheric phenomena are relatively simple for such a high latitude where the rate of photo-ionization in the F layer near midwinter is zero. For the same reason, it varies only slightly through the day near midsummer. Thus any changes in ionization generated by movements in the layer are more easily seen and interpreted than in locations where photo-ionization may be changing rapidly during the day.

The diurnal variation of the F2 layer critical frequency at Halley Bay in midwinter is shown by the curves linking the circles in Fig. 3, which also shows the corresponding midsummer curve marked by crosses. It is to be noted that, despite the absence of any photo-ionizing radiation from the sun in midwinter, the noon critical frequency exceeds that found in midsummer, when the sun never sets<sup>5</sup>. Clearly the behaviour of the layer must be almost entirely determined by movements of ionization and not by direct solar influences. The curves also show that the critical frequency of the F layer is over three times as high at noon as at midnight in midwinter; this corresponds to an increase of about ten times in the ionization density.

The changes in shape of the layer show that the total electron content below the maximum is also much increased at noon. Detailed studies of the ionograms confirm that these changes are mainly due to horizontal movements of ionization; a new layer moving in and replacing the old during a period of about eight hours. This is the cause of the discontinuity in the curve; for several hours there

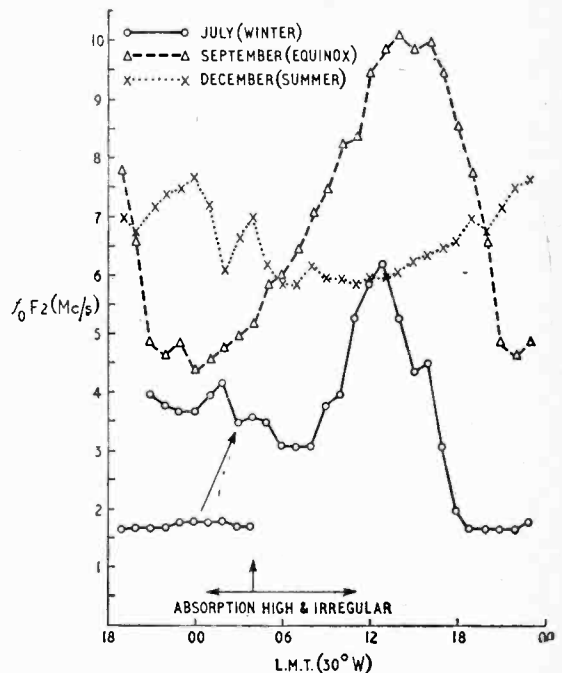

Fig. 3. Monthly median values of  $f_oF_2$  at Halley Bay

are simultaneous reflections from a regular layer which is already overhead and from a second, much denser layer which gradually moves into an overhead position.

The differences between the summer and winter diurnal variations at Halley Bay illustrate a worldwide phenomenon, namely that the phases of the diurnal components of velocity reverse with season. This is responsible for most of the seasonal variations found in practice. Considerable further work will be needed before the regularities discovered during the I.G.Y. can be used as the basis for a theory of the F layer, since the density and shape of this layer in any part of the world depend on the difference between the amount of ionization moved into a zone and that moved out of it. Very small changes in these components can cause enormous differences in the shape of the resultant layer. Nevertheless, the data from the high-latitude stations during the I.G.Y. provide a firm and useful starting point for fuller investigations.

### Use of Rockets and Satellites

During the past decade rockets have been used for research purposes to investigate the phenomena and characteristics of the upper atmosphere by direct measurement in a manner which ground-based experiments are unable to provide. Following this work, it was recommended that during the I.G.Y. observations with rockets should be supplemented by means of artificial earth satellites carrying instruments for the measurement of solar radiation—ultra violet, X and cosmic rays—and its effect on the ionosphere. This recommendation culminated in the successful launching on 4th October and 3rd November, 1957, respectively, by the U.S.S.R., of the instrumented earth satellites known scientifically as 1957 $\alpha$  and  $\beta$ , or more popularly as Sput-

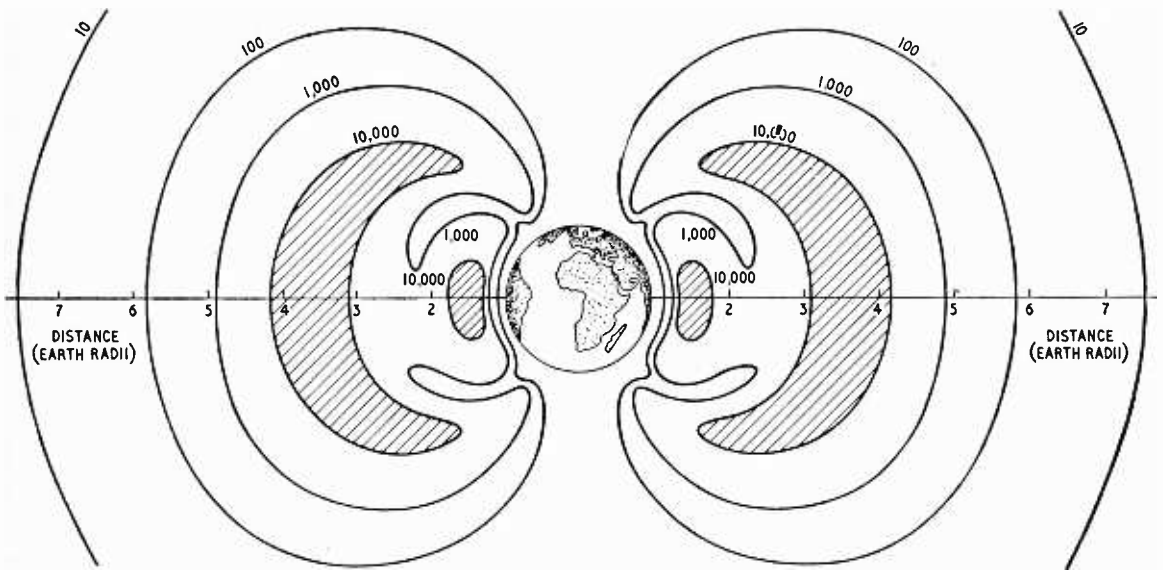

Fig. 4. Structure of radiation belts around the earth (J. A. van Allen). The figures shown indicate the particle density in counts per second.

niks I and II. This was followed on 31st January, 1958 by the U.S.A. satellite 1958 $\alpha$ —Explorer I; and others have followed at intervals during the past two years. At the present time, there are about a dozen satellites in orbit round the earth, while two others are pursuing courses round the sun and moon.

These space vehicles contain instruments for the measurement of the properties of the atmosphere, the electron density of the ionosphere and the intensity of cosmic and solar radiation in outer space. The output of these instruments is in electrical form and is either transmitted directly by radio<sup>6</sup> to the ground observing stations, or is recorded on magnetic tape and sent later on receipt of a command signal from a radio station on the earth. Some of the telemetry systems are relatively simple, providing information in only a few channels; others are more complex and use up to 48 channels. For example, the system used on the 20 Mc/s transmissions from Sputnik III (1958 $\delta$ ) contains three channels, one to indicate whether solar or chemical batteries are in use, and two to record cosmic-ray data. A pulse width system of modulation is used, the information being given by the time interval between successive changes of the pulse width from one discrete value to the next. The American satellites have transmitted the information on a frequency of 108 Mc/s supplemented more recently with higher frequencies. In one of the systems used, the modulation consists of 16 bursts of tone, the information being carried by the tone frequency (5 to 12 kc/s), the duration of the bursts and the interval between them, giving 48 channels in all. The power of transmitters in continuous operation varies from 10 to 100 mW, while for intermittent operation on command, a few watts have been used.

Apart from the need to extract the observational information from the satellite, radio transmission is used to track it and to supplement the positional information which may be obtained visually under favourable clear sky conditions. Radio interferometers and tracking equipment have been installed in

a number of countries to give round-the-world coverage by international co-operation. Additional information provided by the radio signals includes a determination of successive orbit periods, from a knowledge of which information is obtained as to the shape of the earth, variations of gravity at different altitudes and the drag of the rare atmosphere at the orbit levels. Moreover, measurements of the total electron density between the earth and the satellite have been made by comparing the speed of the received waves at a frequency just above the critical frequency of the ionosphere, and at a much higher frequency. The difference in speed at these two frequencies depends upon the total number of free electrons along the path; so the distribution of this number with height can be determined from a continuous record of the difference between the two received frequencies. Both the U.S.A. and U.S.S.R. results have shown no clearly defined minimum in the electron density between the E and F layers; and in the U.S.S.R. results there has been a negligible decrease from the maximum of the F layer up to a height of about 470 km. British experiments with Skylark rockets used a different technique, the change in conductivity and dielectric constant of the ionized air being used to change the frequency of an oscillator. This system has a very rapid response and is capable of showing the fine structure of the ionosphere. In view of the fact that radio methods of sounding the ionosphere from the earth's surface are limited to the lower portion up to the maximum of the F layer, and that it is estimated that there is at least as much more ionization above this layer, the satellite clearly provides a very powerful tool for future ionospheric research.

While research on cosmic rays at high altitudes was in progress before the I.G.Y. by means of balloons and rockets, the scope of the work has been considerably extended by the use of satellites carrying instruments for measuring the intensity and the energy distribution of the radiation. Observations made by U.S. Explorers I and III showed a steady increase in intensity with increase of both altitude

and geomagnetic latitude. Similar trends were shown by observations made with the U.S.S.R. Sputniks II and III. The American observers also noted a very rapid increase in intensity at a height of about 1,000 km; and further observations with Explorer IV have confirmed the existence of regions of intense radiation extending partly round the earth. The release of information on the coding of the telemetry signals used in both U.S.A. and U.S.S.R. satellites has enabled confirmatory observations to be made at Slough on Sputnik III in transit over this country, and on Explorer I in Japan.

The discovery by van Allen<sup>7</sup> and his colleagues of the high-intensity radiation belts which surround the earth is one of the outstanding results of the I.G.Y. Later observations made with Explorer IV and Pioneer III have indicated the existence of two belts<sup>8</sup> of high-intensity radiation around the geomagnetic equator, the first at a height of about 10,000 km and the second at about 22,000 km, as illustrated in Fig. 4. These belts consist of charged particles, the density of which, measured by the rates recorded on a Geiger counter, varies over a range of 10,000 to 1 under different conditions. Much speculation has taken place as to the origin of the radiation, but it is thought that the charged particles are trapped in the earth's magnetic field. On this hypothesis, the particles, travelling towards the earth, are subject to a force at right angles to both their initial motion and the magnetic field, causing them to pursue a spiral path. As they approach the earth, the increasing strength of the field results in a steadily increasing transverse velocity and the particles move in a closer and closer spiral. This is the result of the gradual translation of the initial energy of the particles from that of forward motion along the path into transverse rotational form. At a point in the earth's outer atmosphere where the magnetic field is sufficiently intense, the motion of the particles along the lines of force is reduced to zero (see Fig. 5). This, however, is virtually an unstable condition, from which the particles can be displaced by collision with other particles or molecules. Since they cannot advance further towards the earth, the streams of particles start to retrace their spiral path along the lines of magnetic force to the conjugate point of the earth's field, where the process is repeated. Thus, although there may be some leakage of particles in the course of their travel, the incoming streams of particles may be regarded as virtually trapped in the earth's magnetic field, and as travelling in spiral paths about the lines of force and being subject to reflection between the conjugate points of the field near the earth's surface. As the earth rotates these spiral paths may be regarded as revolving in a direction depending on the sign of the charged particles, so that toroidal belts of high intensity will be formed around the earth as indicated in Fig. 5. Further research and observations are required to establish the properties and structure of these radiation belts, but the knowledge of their

existence must be taken into account in future investigations of the space beyond the earth's atmosphere.

In concluding this section, attention may be drawn to the fact that radio signals from the American satellite Pioneer IV (1959  $\delta$ ) sent in orbit round the sun on 3rd March 1959 were received out to a distance of 400,000 miles<sup>9</sup>. This has established a record for direct radio communication with man-made sending and receiving equipment. Furthermore, the Russian satellite, Lunik III, which made a circuit of the moon towards the end of October, established a distance record for photographing the far side of the moon from a distance of the order of 300,000 miles, and transmitting the pictures back to earth by radio technique.

Although it was not strictly part of the I.G.Y. programme, reference may be made to the Argus experiment conducted by the U.S. authorities in August and September, 1958, when three small nuclear devices were detonated at an altitude of about 480 km (300 miles) in the South Atlantic. One of the I.G.Y. satellites, Explorer IV (1958  $\epsilon$ ), contained instruments designed to measure the natural radiation in the van Allen belts. On 27th August a large increase in the intensity of the radiation was recorded by the satellite as it passed through the locality of the explosion some 3½ hours later. Similar, though smaller, effects were observed after the second explosion four days later, together with residual effects from the first event. Although observations were made on very low frequency radio propagation and on the atmospheric noise level, no definite results were recorded.

## Conclusion

In concluding this very brief review of the manner in which the I.G.Y. was associated with radio, two points must be emphasized. First, that the successful exploration of our atmosphere and the outer space beyond depends to an increasing extent on the technique of electronics and radio communications. Secondly, it is clear that the international exercise which was designated the I.G.Y. did not end on 31st December, 1958. The following year was termed

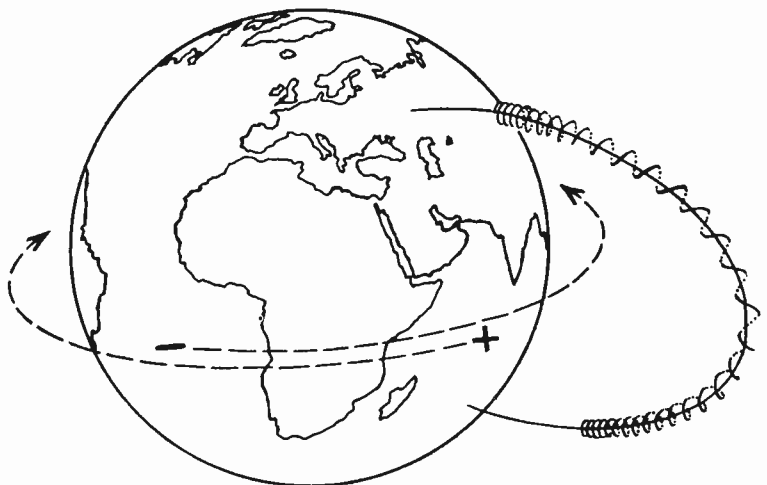

Fig. 5. Diagram showing spiral path of charged particles trapped along magnetic lines of force

**International Geophysical Co-operation—1959;** and it has also been recommended that as far as practicable the various observatories should continue to work in their respective disciplines to extend our knowledge of the earth and its surroundings. It has further been recommended that the World Data Centres established for the I.G.Y. and extended for the results obtained with rockets and satellites, should be continued indefinitely as international repositories of the observational information which is to be freely available for research workers in the future.

## REFERENCES

- <sup>1</sup> R. L. Smith-Rose "Geophysical Research" *Wireless World*, April, 1955, Vol. 61, pp. 188-190.
- <sup>2</sup> "Revision of Atmospheric Radio Noise Data" *C.I.R. Documents of the VIIIth Plenary Assembly*: Warsaw 1956, Vol. 1, pp. 324-358.

- <sup>3</sup> J. O. Thomas and M. D. Vickers "The Conversion of Ionospheric Virtual Height-Frequency Curves to Electron Density-Height Profiles" D.S.I.R. Radio Research Special Report No. 28, H.M. Stationery Office, London.
- <sup>4</sup> J. S. Greenhow and E. L. Neufeld "Measurements of Turbulence in the Upper Atmosphere" *Proc. Phys. Soc.*, 1959, Vol. 74, pp. 1-10.
- <sup>5</sup> W. R. Piggott and W. H. Bellchambers "Ionospheric Measurements made at Halley Bay" *Nature*, Vol. 182, pp. 1596-1597, Dec. 6, 1958.
- <sup>6</sup> J. A. Ratcliffe "Information by Radio from the Satellites" *Journal I.E.E.*, 1958, Vol. 4, pp. 603-8.
- <sup>7</sup> J. A. van Allen and L. A. Frank "Radiation around the Earth to a Radial Distance of 107,400 km" *Nature*, February 14, 1959, Vol. 183, pp. 430-434.
- <sup>8</sup> J. A. van Allen, Carl E. McIlwain and G. H. Ludwig "Radiation Observations with Satellite 1958" *Journal of Geophysical Research*, 1959, Vol. 64, pp. 271-286.
- <sup>9</sup> J. A. van Allen and L. A. Frank "Radiation Measurements to 658,300 km with Pioneer IV" *Nature*, July 25, 1959, Vol. 184, pp. 219-225.

## NEW BOOKS

**High Fidelity Sound Reproduction.** A collection, edited by E. Molloy, of essays by leading authorities on subjective and objective judgment of performance, acoustics of sound reproduction, multiple-channel systems, amplifiers, moving-coil and electrostatic loudspeakers, disc and tape records and radio reception. Pp. 208; Figs. 155. Price 20s. George Newnes Ltd., Tower House, Southampton Street, London, W.C.2.

**Topics in Electromagnetic Theory** by Dean A. Watkins. Unified treatment of aspects of field theory having a direct bearing on the design of microwave valves and allied devices. Sections include periodic transmission systems, the helix, coupled-mode theory and anisotropic media (ferrites). Pp. 118; Figs. 185. Price 52s. Chapman & Hall, 37 Essex Street, London, W.C.2.

**The Calculation of the Median Sky Wave Field Strength in Tropical Regions** by W. R. Piggott, O.B.E., B.Sc. D.S.I.R. Radio Research Special Report No. 27 on the principles and method of predicting the field strength of h.f. broadcast transmissions at low latitudes. Pp. 37; Figs. 28. Price 2s 6d. H.M. Stationery Office, York House, Kingsway, London, W.C.2.

**Modern Electronic Components** by G. W. A. Dummer, M.B.E., M.I.E.E., S.M.I.R.E. Comprehensive and concise survey of components with chapters on planimetric testing, specifications laid down by Industry and the Services and an extensive bibliography. Pp. 472; Figs. 225. Price 55s. Sir Isaac Pitman & Sons Ltd., Parker Street, London, W.C.2.

**Principles of Frequency Modulation** by B. S. Camies. A comprehensive account of the theory of f.m. broadcast transmission and reception, interference rejection, methods of detection and the applications of f.m. in radar and communications systems, including facsimile. Pp. 147; Figs. 78. Price 21s. Iliffe & Sons Ltd., Dorset House, Stamford Street, London, S.E.1.

**General Circuit Theory** by Gordon Newstead. Compact account of the mathematical tools used in the analysis of complex circuits. Circuit elements, general network theorems, four-terminal network in the steady and transient states and some extensions of linear circuit theory to non-linear elements. Pp. 144; Figs. 20. Price 15s. Methuen & Co. Ltd., 36 Essex Street, London, W.C.2.

**Fundamentals of Transistors** by Leonard M. Krugman. Second (Revised) edition now includes references to surface barrier, intrinsic, drift, avalanche and spicistor types; and illustrative circuits in the amplifier, oscillator and h.f. application sections have been brought

up to date. Pp. 168; Figs. 120. Price 25s. Chapman & Hall, 37 Essex Street, London, W.C.2.

**Théorie et Pratique des Circuits de l'Electronique et des Amplificateurs. Tome I: Applications du calcul des imaginaires à l'étude des circuits.** By J. Quinet. Comprehensive treatise on the use of complex algebra and circuit theorems in the analysis of radio and electronic circuits. Pp. 256; Figs. 160. Price, 1960F. Dunon-Editeur, 92 rue Bonaparte, Paris 6<sup>ème</sup>.

**Radio Studies of the Universe** by R. D. Davies and H. P. Palmer. Broad survey against the background of optical astronomy of the methods and results of radio astronomy, by two members of the staff of Jodrell Bank observatory. Pp. 200; Figs. 50 and 14 plates. Price 25s. Routledge & Kegan Paul Ltd., 68-74 Carter Lane, London, E.C.4.

**Bringing the Aerial Down to Earth** by R. S. Roberts, M.Brit.I.R.E., S.M.I.R.E. Simple exposition of the technical background of television aerials and their installation. Pp. 33. Available from Wolsey Electronics Ltd., Cray Avenue, St. Mary Cray, Orpington, Kent.

**My Story of the B.B.C.** by Freddy Grisewood. A first-hand account of the B.B.C. from the inside from 1929 to the present day; primarily from the programme point of view but with much interesting technical information. Pp. 224; 29 illustrations. Price 21s. Odhams Press Ltd., 96 Long Acre, London, W.C.2.

**Rapid Radio Repair** by G. Warren Heath. Illustrated guide to bench techniques in locating and remedying faults in sound broadcast receivers. Subject matter arranged alphabetically for quick reference. Pp. 224; Figs. 81. Price \$2.90. Gernsback Library Inc., 154 West 14th Street, New York, 11.

**Abbreviations of Associations, Institutions, Research and Trade Associations.** B.E.A.M.A. Publication No. 159 with more than 400 entries giving the titles and addresses of organizations in the electrical and allied fields. Pp. 16. Price 1s 6d. The British Electrical and Allied Manufacturers' Association, 36 Kingsway, London, W.C.2.

**Principles of Electronics** by M. R. Gavin, M.B.E., D.Sc., F.Inst., M.I.E.E., and J. E. Houldin, B.Eng., Ph.D., A.M.I.E.E. Book of first principles designed to provide the common background for physicists and electrical engineers prior to specialization in any of the many branches of electronics. A collection of 250 examples based on typical examination questions is given. Pp. 348; Figs. 309. Price 30s. The English Universities Press Ltd., 102 Newgate Street, London, E.C.1.



# Signal-Flow Diagrams

## I.—Graphical Aids to the Solution of Complicated Circuits

By THOMAS RODDAM

A SIGNAL-FLOW diagram is a topological model of a system of linear simultaneous equations. In less dignified language, like what you expect of the likes of me, it is a map of what goes on inside a circuit and, like all good maps, it gives you a chance of finding a short-cut or two. The signal-flow diagram is starting to become fashionable in America, where it was first described six years ago by S. J. Mason in *Proc. I.R.E.* for Sept. 1953 (p. 1144), so that in any event you need to know something about it. This article is an attempt to explain what signal-flow diagrams are and how you use them without actually being blinded by science. It does not quite follow the line taken by R. F. Hoskins in *Electronic and Radio Engineer* (August 1959, p. 298) for a reason I shall make clear when I get to it.

We must start off with some rather dreary-looking G.C.E. or O.N.C. algebra before getting to a practical circuit. Bear with me, because it is necessary to get this first step clear: after all you would never have learned French if you had let your aunt's gardener keep that pen. Suppose we have a system with three points, which could be anode, cathode

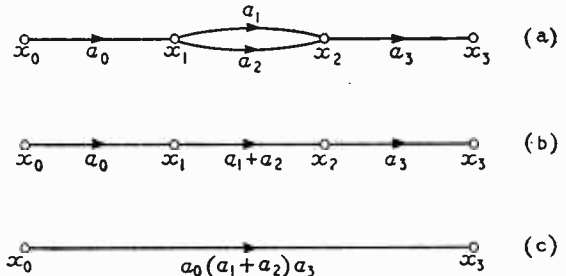

Fig. 3. Simplification with series and parallel branches.

and grid of a valve, and we associate a variable, which could be voltage, with each. The variables are  $x_0, x_1, x_2$  and by ordinary circuit methods we find that:

$$\begin{aligned} a_0x_0 + a_1x_1 + a_2x_2 &= 0 \\ b_0x_0 + b_1x_1 + b_2x_2 &= 0 \end{aligned}$$

where the  $a$ 's and  $b$ 's are constants.

These equations can be solved by ordinary algebra, or by using determinants. We could write

$$x_0 = -\frac{a_1}{a_0}x_1 - \frac{a_2}{a_0}x_2$$

which Hoskins virtually does, but there is a risk in starting off like this because you then need to apply special tests for stability if  $a_0 = 0$ . It seems a pity to be forced to choose between doing this and manoeuvring round the concealed infinities which may be scattered through the algebra. Another method seems indicated and it is found by writing

$$\left. \begin{aligned} x_1 &= a_0x_0 + (a_1 + 1)x_1 + a_2x_2 \dots \\ x_2 &= b_0x_0 + b_1x_1 + (b_2 + 1)x_2 \dots \end{aligned} \right\} (1)$$

Now let us construct the signal-flow diagram, starting from  $x_0$ , the input signal. Operating in easy stages, Fig. 1(a) shows the three points,  $x_0, x_1, x_2$ . Notice that the points on the signal-flow diagram have the same names as the variables, because this is essentially a map of the signals. Looking at the first equation of (1) we see that we reach  $x_1$  by taking  $a_0x_0$  so in Fig. 1(b) we draw a line from  $x_0$  to  $x_1$ , put an arrow on it to indicate "to  $x_1$ " and write  $a_0$  alongside the arrow; we add the line  $a_2x_2$  from  $x_2$  and the "round-the-houses" line  $(a_1 + 1)x_1$  from  $x_1$  to  $x_1$ . From  $x_0$  to  $x_2$  involves the same sort of operations and is shown in Fig. 1(c). Since the equations are simultaneous the two partial maps must be put together and they then form Fig. 1(d).

We can now use this map to study the way in which maps of this kind can be simplified. Suppose we look at Fig. 2(a). The signal entering  $x_2$  is provided by two branches and gives us

$$x_2 = a_1x_1 + a_2x_1 = (a_1 + a_2)x_1$$

so that we can reduce this little map to the even

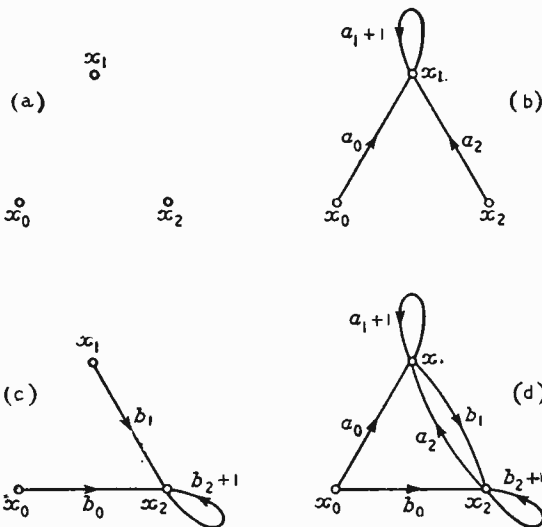

Fig. 1. Construction of the signal flow diagram of the two equations (1) in the text.

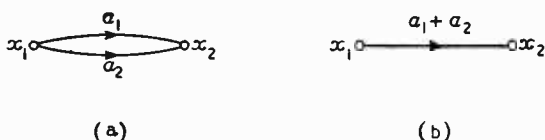

Fig. 2. Simplification of a signal-flow diagram with parallel branches.

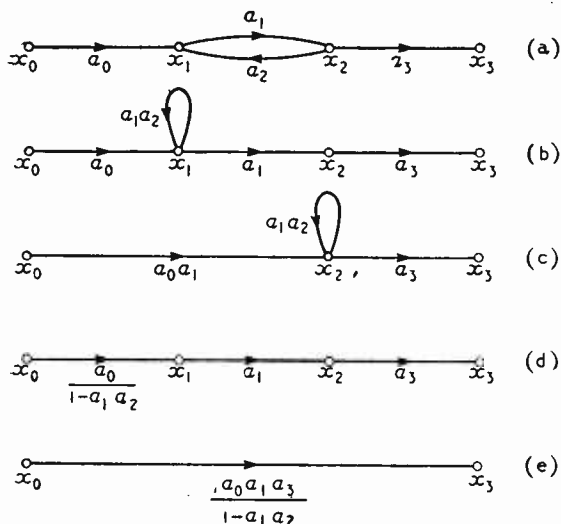

Fig. 4. Simplification with a reversed loop does not just mean writing a minus sign.

simpler form shown in Fig. 2(b). This same simplification has been carried out to get from Fig. 3(a) to Fig. 3(b), from which we see that,

$$x_1 = a_0x_0$$

$$x_2 = (a_1 + a_2)x_1$$

$$x_3 = a_3x_2$$

so that  $x_3 = a_3(a_1 + a_2)a_0x_0$

which has the map shown in Fig. 3(c).

The diagram shown in Fig. 4(a) is deceptively like the one shown in Fig. 3(a) and it is very tempting to write  $-a_2$  in place of  $a_2$  and twist the arrow round. This is quite fatal. You just mustn't drive backwards down a one-way street. Signal-flow, like traffic flow, has its own rules and it is no good trying to use the rules you learnt for something else. Let us see what Fig. 4(a) means. We have

$$x_1 = a_0x_0 + a_2x_2$$

$$x_2 = a_1x_1$$

$$x_3 = a_3x_2$$

so that substituting in the first equation

$$x_1 = a_0x_0 + a_1a_2x_1$$

$$x_1(1 - a_1a_2) = a_0x_0$$

$$x_2 = a_1x_1$$

$$x_3 = a_3x_2$$

The first of the equations for  $x_1$ , taken with the last two, gives us the diagram shown in Fig. 4(b). This has a self-loop at  $x_1$ . We could have made the substitution in the second equation, giving

$$x_2 = a_0a_1x_0 + a_1a_2x_2$$

$$x_3 = a_3x_2$$

which gets rid of  $x_1$  altogether and produces the diagram shown in Fig. 4(c). Alternatively we could go on from the form

$$x_1 = a_0x_0/(1 - a_1a_2)$$

$$x_2 = a_1x_1$$

$$x_3 = a_3x_2$$

to get Fig. 4(d), which contains no self-loop. You see how the self-loop  $a_1a_2$  at  $x_1$  reacts on the  $a_0$  term entering  $x_1$  from  $x_0$  to give  $a_0/(1 - a_1a_2)$ . This agrees with the idea of a self-loop, or indeed a reversed loop like the one we began with, as a feed-

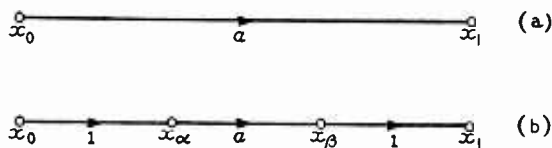

Fig. 5. Introducing test points in a signal-flow diagram.

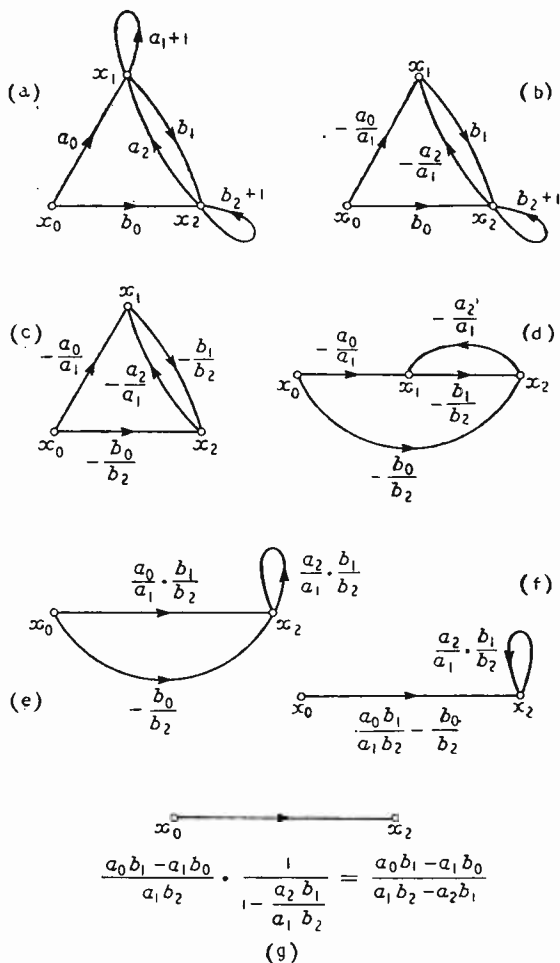

Fig. 6. The step-by-step reduction of (a) (Fig. 1(d)) representing the equations (1) leads to the solution (g).

back loop. The last step in the reduction is shown in Fig. 4(e).

Before we go back to try and simplify Fig. 1(d) we might notice a trick which is convenient in avoiding confusion. We can do the reduction of Fig. 3(b) to Fig. 3(c) in reverse in the way shown in Fig. 5. Here I have put in a couple of test-points  $x_\alpha$  and  $x_\beta$  without altering the overall flow from  $x_0$  to  $x_1$ .

Back, then, to Fig. 1(d). If we look first at  $x_1$  we see that we have a self-loop and two entering signals: the figure is redrawn as Fig. 6(a) and the self-loop has been eliminated in Fig. 6(b) by dividing both entering signals by  $1 - (a_1 + 1) = -a_1$ . In Fig. 6(c) the second loop has been eliminated and this figure is then redrawn as Fig. 6(d). To get this even

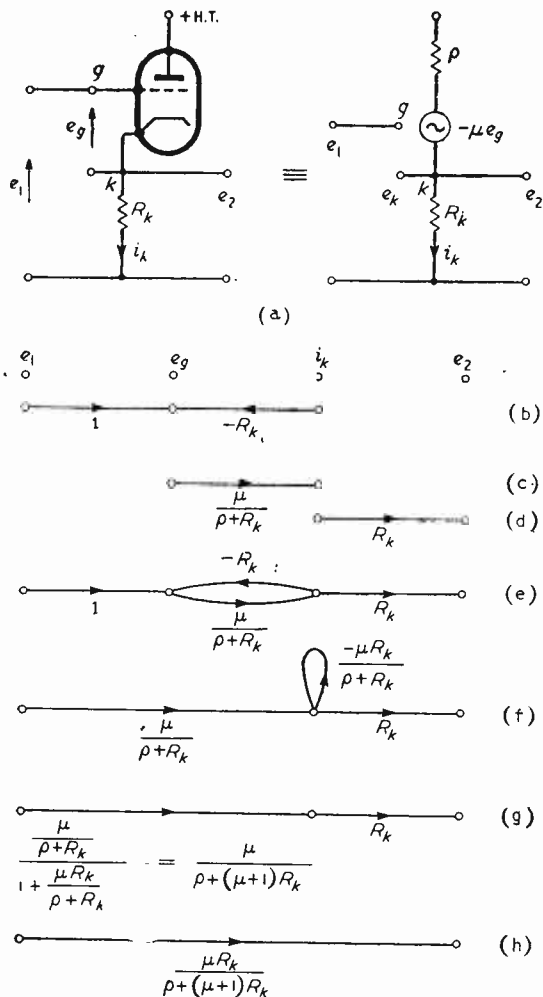

Fig. 7. Circuit of a cathode follower and the construction and reduction of its signal-flow diagram.

simpler we collapse the top-half of the map as in Fig. 4(c) to give Fig. 6(e). The two branches from  $x_0$  to  $x_2$  are then run together in Fig. 6(f) and in Fig. 6(g) the self-loop at  $x_2$  is eliminated by the method we have already described. The answer we have reached is

$$x_2 = \frac{a_0 b_1 - a_1 b_0}{a_1 b_2 - a_2 b_1} \cdot x_0$$

which those skilled with determinants could have written down right away. Of course, the whole operation is merely the elimination of  $x_1$  between the two original equations and in this particular case it would have been much easier to solve the problem directly. When you turn to more complicated problems, however, there is a lot to be said for working on each small area of the equations without having to carry all the rest along with you and without needing to make a lot of substitutions. You do not need Kirchhoff's laws or Maxwell's circulating currents to calculate a voltage divider but you will get thoroughly tied up without these aids if you are dealing with a three-stage ladder network with a bridge across the top. So with the signal-flow

diagram the more complex the problem the more powerful the tool appears to be.

The moment has come to write down some of the rules of the game in a neat list. As given by J. G. Truxal in "Automatic Feedback Control System Synthesis" (McGraw-Hill, 1955) they are:

1. Signals travel along branches only in the direction of the arrows.
2. A signal travelling along any branch is multiplied by the transmittance of that branch.
3. The value of the variable represented by any node (intersection point) is the sum of all signals entering that node.
4. The value of the variable represented by any node is transmitted by all branches leaving that node.
5. The diagram is always drawn so that no branch enters the input node and none leaves the output node.

There is nothing like a practical example to clarify matters. The mapping and reduction exercise above was devised, like all good exercises, to feature all the procedures you may need. We may permit ourselves something a little simpler, with one of the lessons only a practical case can involve, in preparation for a real problem next month. The circuit is shown in Fig. 7(a) and is, of course, our old friend the cathode follower. We can write down some equations for this:

$$\begin{aligned} e_g &= e_i - i_k R_k \\ i_k &= \mu e_g / (\rho + R_k) \\ e_2 &= i_k R_k \end{aligned}$$

These three equations give us the partial maps of Figs. 7(b), (c) and (d), which we can put together in the form of Fig. 7(e). This time one of the nodes is  $i_k$ , a current, although all the others are voltages. It does not matter, the rules are still obeyed, but you will notice that when an arrow points from  $e_1$  to  $e_g$  it bears a transmittance which has zero dimensions but from  $e_g$  to  $i_k$  the dimensions are conductance,  $1/R$ , and from  $i_k$  to  $e_2$  they are resistance. Clearly if two nodes are joined by several branches they must all have the same dimensions and this forms a useful check in complex systems.

The results which have been obtained and the conclusions which may be drawn are worth recapitulation. The signal-flow diagram provides a map of the passage of signals through the circuit. Feedback loops are indicated very clearly, as you can see in Fig. 7(e), and this is true even if there are a number of loops. Although there is nothing in the diagrams which was not in the simultaneous equations, elimination of the dependent variables is often much easier because attention can be concentrated on them one at a time.

Next month I propose to deal with a fairly complicated circuit which most of us would think twice about in its conventional treatment. This will give the signal flow diagram a chance to show its advantages.

"From Us To View," a new Mullard film, sets out to show something of the skill and care that go to ensure the high quality of television pictures. It traces the progress of the picture from its beginning in the studio to its appearance in the living room. The 16-mm black and white sound film, which runs for 23 minutes, is available to clubs and other interested organizations on free loan from Mullard House, Torrington Place, London, W.C.1.

# WORLD OF WIRELESS

## Servicing Examinations

THE Radio Trades Examination Board's syllabuses for sound radio and television servicing have been in operation virtually unchanged since the examinations were first set some years ago. During the past year (reviewed in the Board's 15th annual report) a complete revision of the two syllabuses took place. Apart from revising the material itself an opportunity was taken to combine the sound radio and television subject matter so that there is one syllabus leading up to the issuing of one certificate covering both subjects. The Board will now provide an intermediate examination at the end of the third year of a part-time course and a final examination at the end of the fifth year.

The Board's proposed scheme for certificates for those engaged in installing and servicing "non-domestic" electronic equipment has moved a stage further and a syllabus has now been prepared. It is arranged so that the syllabus for the first two years is common with that for sound radio and television servicing, but separate intermediate and final examinations in electronics are to be held. The first examination will be at the intermediate level in 1961.

The domestic radio and television manufacturing side of the industry is already represented on the Board by B.R.E.M.A. and an invitation has now been extended to the Electronic Engineering Association to be represented.

At the annual general meeting of the Board on December 30th, E. A. W. Spreadbury, technical editor of *Wireless & Electrical Trader*, was elected chairman in succession to E. M. Lee (Belling & Lee).

## I.T.A. Masts

MODIFICATIONS to the aerials at three I.T.A. stations are mentioned in the Authority's recently published report for 1958/59. "Whatever finally happens about the siting of television stations in London, there are good technical reasons for making improvements as soon as possible at Croydon" where there is a temporary 200-foot tower. The Authority is satisfied that experience has allayed earlier fears that the radiation of signals from two high towers, one at Crystal Palace (B.B.C.) and one a mile away at Croydon (I.T.A.), might be harmful to reception because of mutual reflection between the two towers. Plans for a new 500-foot tower and "tailored" aerial system have been referred to the Television Advisory Committee. It will be recalled that the height of the B.B.C.'s mast

was extended at the instigation of the P.M.G., in order to accommodate the aerials of both the B.B.C. and I.T.A. stations.

At Black Hill, central Scotland, where the aerial is unusual in that the elements are located centrally within the 750-foot mast, both the aerial and the mast are to be replaced; it is hoped by the autumn of this year. The present mast will subsequently be dismantled for use elsewhere.

At Lichfield the existing 450-foot tower is to be replaced by a 1,000-foot mast with a new aerial designed particularly to improve reception in the south-westerly direction.

**Dip. Tech.**—A second list of students on whom the National Council for Technological Awards has conferred Diplomas in Technology, has been issued. Of the 82 successful candidates, 49 took electrical engineering at the Birmingham College of Advanced Technology, and all but three of these received their industrial training with the G.E.C. The total number of holders of the Dip. Tech. is now 207. There are now 3,320 students studying for the Diploma compared with 1,786 a year ago.

**Space Science Symposium.**—A British delegation of 40 people led by Professor H. S. W. Massey, F.R.S., chairman of the British National Committee on Space Research, attended the first International Space Science Symposium held in Nice from January 11th to 16th. Organized by the Committee on Space Research (COSPAR) of the International Council of Scientific Unions, it was attended by delegations from nearly 20 countries.

**Stereophonic Broadcasting.**—A time-multiplex system for broadcasting stereophony has been developed by G. D. Browne, of Mullard Research Laboratories, and has been submitted to the European Broadcasting Union for assessment. Details of the system have not yet been released but it is known that stereophonic v.h.f. receivers could be produced with the addition (apart from the extra loudspeaker and audio stage) of not more than two valves or possibly one transistor and two diodes. The system is compatible for mono and stereo broadcasts.

**B.S.R.A.**—A one-day convention covering post-war developments in recording, pickup design and cinema sound systems, is being organized by the British Sound Recording Association during the forthcoming Audio Fair. It will be held on April 23rd at the London School of Hygiene and Tropical Medicine, Keppel Street, W.C.1. Registration will cost 5s for B.S.R.A. members and 10s for non-members. Details are obtainable from S. W. Stevens-Stratten, Greenways, 40 Fairfield Way, Ewell, Surrey.

**"The Computer in Production."**—The Institution of Mechanical Engineers is arranging an informal discussion on the computer in production in order to introduce mechanical engineers and managers to the latest techniques involving the application of computers in production and to provide a forum for users to present their views to computer manufacturers. The meeting will be held on March 21st and 22nd. Further details are available from the Secretary, Institution of Mechanical Engineers, 1 Birdcage Walk, London, S.W.1.

**Receiving Licences.**—There were twice as many combined television and sound broadcasting licences in force in the U.K. at the end of November as sound-only licences. The comparative figures were 9,987,005 and 4,960,788.

### "Wireless World" Index

The index to Volume 65 (1959) is now available price 1s (postage 3d). Cloth binding cases with index cost 9s including postage and packing. Our publishers will undertake the binding of readers' issues, the cost being 25s per volume, including binding case, index and return postage. Copies should be sent to Hiffe & Sons, Ltd., Binding Department, c/o 4 Hiffe Yard, London, S.E.17, with a note of the sender's name and address. A separate note, confirming despatch, together with remittance should be sent to the Publishing Department, Dorset House, Stamford Street, London, S.E.1.

**Information Engineering** is among the subjects for which M.Sc. degree courses are being conducted by the University of Birmingham. These courses, which are "primarily intended for honours graduates of approved universities" differ from the traditional one of original research leading to the degree of M.Sc. Suitably qualified students (preferably with some industrial experience) can obtain the degree on the satisfactory completion of the 12-month course, of which the next session starts on October 1st, 1960. Subjects available in the information engineering course include communications, radar, computers and control systems, with some degree of choice to suit individual requirements. Full details are obtainable from Dr. D. A. Bell, Supervisor of Graduate Courses, The University, Edgbaston, Birmingham, 15.

The **CIBA Fellowship Trust**, which was founded for the purpose of furthering the exchange of ideas between scientists in the United Kingdom and on the Continent, announces that several fellowships will be awarded for tenure during the academic year 1960/61 at Continental universities or institutions for research in chemistry, physics or some allied scientific subject. They will be awarded to graduates of U.K. universities or to members of those universities graduating this year. The basic award for Fellows will be £800 per annum, plus allowances. Details are available from the secretary of the CIBA Fellowship Trust, CIBA (A.R.L.), Ltd., Duxford, Cambridge.

**T.E.M.A. Awards.**—For the third year the Telecommunication Engineering and Manufacturing Association has held a competition for the best final year apprentices (graduate, student and technician) among their member-firms. Awards to the value of £25 will be presented to each of the following at the Association's annual dinner on February 17th: P. J. Langlois, graduate in training, of S.T.C.; P. N. T. Wells, student apprentice, of G.E.C.; and J. R. Bryden, technician apprentice, of Ericsson.

**Hendon Technical College**, London, N.W.4, is holding a ten-lecture evening course on electronic measurements on Tuesdays from January 26th. Fee £1.

**Twickenham Technical College**, Middx., is providing a special course of ten evening lectures on printed circuit techniques. The course begins on February 3rd. Fee £1.



**U.S.A. Tour.**—Malcolm Church (left) a 21-year old apprentice of Plessey, Swindon, being congratulated by the Mayor of Swindon on his selection for a six-month tour of America to study engineering techniques and production methods. On the right is F. B. Langworthy, "the best apprentice to complete his training" in 1959. The Mayor presented prizes to nearly 50 apprentices. A. E. Underwood, the company's resident director at Swindon, is second from the left.

**Craftsmanship and Draughtsmanship.**—With the object of encouraging craftsmanship and draughtsmanship in the scientific instrument industry a competition mainly for young workers of either sex is held each year by the Physical Society. Twenty-four prizes were awarded to successful entrants at the Society's recent exhibition at which the entries were on display. The Silvanus P. Thompson prize was awarded to Christopher Samms of Marconi's W/T Cc. for a mechanical drive unit. In the electronic circuitry section prizes were won by David Elliot (Marconi's), John Butler (Hilger & Watts) and John Mills (Marconi's), and in the microwave components section by James Danbury (Services Electronics Research Lab.), Roy Tucker (Hilger & Watts) and Adrian Short (Services Electronics Research Lab.).

**Paris Components Show.**—Although listed in the diary of conventions and exhibitions in our January issue as the French Components Show, the exhibition to be held in Paris from February 19th to 23rd is international in character. This is the third International Components Exhibition to be organized by the Industries' Association for Radio and Electronic Components and Accessories (S.I.P.A.R.E.) under the patronage of the National Federation of Electronic Industries (F.N.I.E.).

**Nigeria's** first two television stations, which have been in service since the beginning of November, operate on 625-lines in Band I. The station at Ibadan, the regional headquarters of Western Nigeria, radiates on 66.25Mc/s vision, and 67.75Mc/s sound (European channel 4), with an e.r.p. of 1.5kW. The station at Abafon, serving the Lagos area, operates on 55.25 and 60.75Mc/s (channel 3) with a 15kW e.r.p.

**ELSIE**, the Post Office Electronic Letter Sorting and Indicator Equipment, will be among the features in the display at this year's Ideal Home Exhibition (Olympia, March 1st to 26th), depicting the 300 years' growth of the G.P.O. since the King Charles II "Act for the Erection and Establishing a Post Office."

**"Teletype."**—The Western Electric Company have informed us that the word "Teletype," used in our report of the Radio Hobbies Exhibition (January, 1960, issue) is a registered trade mark of the Teletype Corporation who are associates of Western Electric Co.

## CLUB NEWS

**Bexleyheath.**—At the February 11th meeting of the North Kent Radio Society, W. J. Green (G3FBA) will discuss the design and construction of a multi-band transmitter which will not interfere with television. On the 25th there will be a demonstration of mono and stereo equipment. Meetings are held at 8.0 at the Congregational Hall, Chapel Road.

**Birmingham.**—A 160-metre mobile rally at Lickey Beacon, Rednal, has been arranged by the South Birmingham Radio Society for 10.30 a.m. on February 7th. The monthly club lecture meeting will be held on the 18th at 9.30 at Friends Meeting House, 220 Moseley Road, Birmingham, 12.

"15 watts in 50 countries" is the title of the talk to be given by R. Roberts, of the B.B.C., to members of the Midland Amateur Radio Society on February 16th. Meetings are held at 7.0 at The Birmingham Midland Institute, Paradise Street.

G. T. Peck, of Ernest Turner Electrical Instruments, will lecture on electronics in the search for oil at the February 26th meeting of the Slade Radio Society which meets on alternate Fridays at 7.45 at The Church House, High Street, Erdington.

**Bradford.**—David Pratt (G3KEP), secretary of the Bradford Amateur Radio Society will give a talk entitled "Inexpensive sound fidelity" at the club meeting on February 9th at 7.30 at Cambridge House, 66 Little Horton Lane.

**Reading.**—A representative of E.M.I. Sales & Service is giving a lecture-demonstration of high-quality sound equipment to members of the Calcot Radio Society on February 18th. Monthly meetings are held at 7.45 at St. Birinus Church Hall, Calcot.

# News from the Industry

**Ultra Reorganization.**—Two subsidiary companies have been formed by Ultra Electric (Holdings) Ltd. Mr. E. E. Rosen, chairman and managing director of the company since its formation forty years ago, will continue as chairman of the holding company and of the subsidiaries, with A. V. Edwards as managing director of each of the subsidiaries. The two new companies are Ultra Radio and Television Ltd. (which has its own subsidiary, Pilot Radio and Television Ltd.), handling domestic sound and television equipment, and Ultra Electronics Ltd., which will handle the activities formerly covered by the Special Products Division. Trevor C. Standeven, who joined Ultra eighteen months ago from Radio and Allied Industries, is general manager of Ultra Radio and Television, A. Bamford, technical manager, and W. H. De Val, works manager. They are also members of the board. L. R. Crawford is general manager of Ultra Electronics, Dr. F. W. Stoneman, who joined the organization from Smith's Aircraft Instruments last June, is chief engineer, J. S. Williams is works manager and E. R. Wright, commercial manager. They are also members of the board.

**Camp Bird's** 57th annual report and statement of accounts presented at the annual general meeting on December 31st records that the group's consolidated earnings before taxation were the highest in the company's history—£666,709, compared with £578,840 the previous year. Reference is made by John Dalglish (chairman) in his review to the activities of the subsidiaries, including Hartley Baird (see below), Electronic Reproducers (previously known as E.V. Ltd., but not to be confused with E.V. Industrials) and A. Prince Industrial Products, distributors of a number of overseas products, including such names as Blue Spot, Dual and Akkord.

**Hartley Baird Ltd.**, in their report for the year ended last April, record a group profit of £54,402 after taxation. During the year under review the company disposed of its share holding in Ambassador Radio and Television Ltd., which is now owned jointly by Camp Bird and an unnamed company. It is understood Ambassador are not continuing in the domestic sound and television receiver field. The Hartley Baird group includes Hartley Electromotives Ltd., manufacturers of the Taperiter dictating machine, and Duratube & Wire Ltd.

**H.M.V. and Marconiphone** sound and television receivers and radio-gramophones will in future be distributed by British Radio Corporation Ltd. (21 Cavendish Place, London, W.1, Tel.: Langham 9291) instead of by the sales companies ("His Master's Voice" Radio & TV Sales and Marconiphone Radio & TV Sales), which ceased to operate on January 1st. Matters relating to accounts will be handled by B.R.C. at 270 Great Cambridge Road, Enfield (Tel.: Enfield 5353).

**Radio Rentals Ltd.** announce a group net profit for the year ended last August of £1,098,616, just over £273,000 above the previous year. This was after allowing £2,968,104 for depreciation and £851,279 for taxation.

**Decca's** recently introduced river radar, type 215, meets the internationally agreed Rhine Radar Specification issued by the Commission Centrale de la Navigation du Rhin. Compliance with this specification allows vessels fitted with radar to continue their passages up or down the Rhine under conditions of poor visibility.

**G.E.C.**—The Leeds branch of the General Electric Co. has moved from Wellington Street to a new building in Gelderd Road.

**Firth Cleveland Group** has recently acquired two organizations in the radio and electronics field. With the acquisition of Broadmead Ltd. on January 4th the group now controls over 500 retail radio stores, including Max Stone, Civic Radio Services and Escott Brothers. The purchase price for Broadmead was £5.8M. John James, the founder and chairman of Broadmead, has joined the board of Firth Cleveland Ltd. The Firth Cleveland Group has also acquired a 53% interest in the Solartron Electronic Group Ltd., which includes fourteen companies in this country and abroad. Charles W. Hayward, chairman of Firth Cleveland, becomes chairman of Solartron. John E. Bolton, who is 39 and was chairman and managing director of the Solartron group, which he joined in 1951, retains his managing directorship but becomes deputy chairman.

**Solartron Electronic Business Machines**, a subsidiary of the Solartron Electronic Group, have received an order for an Electronic Reading Automaton from Domestic Electric Rentals Ltd. The E.R.A. will read directly, at a speed of up to 300 characters per second, information recorded by National Cash Register machines at each branch of the radio-TV rental organization. This information will then be automatically punched on to 80-column cards for subsequent use in a standard punched-card installation.

**Daystrom Ltd.** have moved to new premises at Two Mile Bend, Bristol Road, Gloucester, from their temporary address at Glevum Hall, and an official opening ceremony by the Mayor of Gloucester took place on December 7th. A. E. B. Perrigo, who is managing director, disclosed that 25% of their output of British "Heathkits," of which there are now twenty-two types, is exported.

**Wayne Kerr** have set up a new section to be known as the applications group of the Industrial and Electronics Division. It will be under the direction of G. G. Gouriet, the company's technical director. The administration offices of the new group are at 44 Coombe Road, New Malden, Surrey.

**Wolsey Electronics Ltd.**, of St. Mary Cray, Orpington, Kent, have been appointed sole distributors in the U.K. for Grundig measuring instruments. The range of equipment being handled includes b.f.o.'s, wobblers, valve voltmeters, grid-dip oscillators, resistance and capacitance decodes and stabilized power supplies.

**G. V. Planer Ltd.** have recently completed an extension to their research laboratories at Sunbury-on-Thames, Middlesex. The additional accommodation has been allocated to the growing solid-state physics section and associated X-ray crystallographic group. The research facilities for printed circuit and related techniques under L. S. Phillips have also recently been enlarged.

**Modac connectors**, hitherto produced by Plessey's associate company, Modern Acoustics Ltd., at Boreham Wood, Herts., will in future be manufactured at Plessey's Wiring and Connectors Division at Cheney Manor, Swindon.

**E.M.I.** closed-circuit television is being used to enable one policeman to control four busy traffic lanes at West Drayton, Middx., during reconstruction of a railway bridge spanning the High Street and Station Road.

**Electro Methods Ltd.** have moved their Electrical Connector Division to new premises at Hitchin Street, Biggleswade, Beds., (Tel.: Biggleswade 2086). The divisional manager is D. P. Wright.

**General Electric Co.** has reorganized its General Products Group into five new groups each under the control of a group managing director. The groups, with the name of the managing director in parenthesis, are:— Domestic Equipment Group, incorporating the domestic equipment division (E. A. Fowler); Installation Equipment Group, incorporating the installation equipment division and Pirelli-General cable division (R. H. Phillips); Lighting and Heating Group, incorporating the lighting division and industrial heating department (D. L. Tabraham); Osram Group, incorporating the Osram lamp division and all glass and lamp component units (A. E. Page); and Radio Group, incorporating the radio division (M. M. Macqueen).

## EXPORT NEWS

**Sweden.**—Alma Components Ltd. have appointed AB Solartron, of Hedingsgatan 9, Stockholm NO, as their agents for precision wirewound resistors in Sweden.

**Multi-channel** u.h.f. communication equipment is being supplied by Plessey for installation in vessels of the South African Navy.

**Ghana.**—The Government of Ghana has awarded Marconi's the contract for the design and erection of the transmitting station buildings, the supply and installation of the four 100-kW short-wave transmitters and ancillary equipment, the masts, aerial and feeder systems—in short, an entire external broadcasting station on a "turnkey" basis. In addition Marconi's have contracted to supply technical staff for the supervision and maintenance of the station for a period of four years and to be responsible for training personnel of the Ghana Broadcasting System. Valves for the transmitters will be supplied by English Electric Valve Co. The contract for the complete station at Tema, near Accra, is valued at over £600,000.

**Canada.**—A new microwave link between Moncton and St. John, New Brunswick, using G.E.C. equipment and operating around 2,000Mc/s, was commissioned on December 12th. The installation was carried out by Canadian General Electric Co. The link is primarily for telephones but can be used for television, and work has already begun on extending it from Moncton to Campbellton and from St. John to Halifax and Sydney, Nova Scotia.

# Personalities

**George Macfarlane, Dr. Ing., B.Sc., A.M.I.E.E., F.Phys.Soc.,** a Deputy Chief Scientific Officer at the Royal Radar Establishment, Malvern, has been appointed Deputy Director of the National Physical Laboratory. He succeeds **Dr. Edward Lee**, who becomes Director of Stations and Industry Divisions at the Headquarters of the D.S.I.R. Dr. Macfarlane, who is 43, graduated in electrical engineering at Glasgow University in 1937, and then did two years' post-graduate research at Dresden, where he gained the Dr. Ing.



Dr. G. Macfarlane

degree. He joined the Telecommunications Research Establishment (now R.R.E.) in 1939. Throughout the war he concentrated on mathematical problems in radar and microwave physics and in 1945 became head of the Mathematical Group. Since 1953 he has been carrying out individual research in the Physics Department. Dr. Lee graduated in physics at Manchester University, and after taking his M.Sc. at the University and his Ph.D. at Cambridge University, he joined the Royal Naval Scientific Service in 1939 and was posted to the Admiralty Research Laboratory. He was director of Operational Research at the Admiralty for three years before becoming Deputy Director at the N.P.L. in March, 1958.

**W. G. C. Denny, A.M.Brit.I.R.E.,** who since the war has been in South Africa, has returned to this country and joined the telecommunications division of Elliott Brothers (London) Ltd. as technical sales manager. He was commissioned in the R.N.V.R. in 1941 and from 1942-46 was radar liaison officer on the staff of the Director of Radio Equipment, the Admiralty, Bath. For six years before joining the Navy he was with Western Electric Co., and prior to 1935 was with E. K. Cole and Murphy Radio. Mr. Denny was chairman of the South African section of the Brit.I.R.E. on its formation in 1949.

**M. M. Macqueen**, who has been with the G.E.C. since 1923 when he was appointed assistant to the manager of the company's newly formed Radio Department, has become managing director of the Radio Group under the company's re-organization scheme (see "News from the Industry"). He is 61. Mr. Macqueen has also been appointed a director of General Piped Television, Ltd., a new company (in which G.E.C. has an interest) formed to provide a television relay service to viewers. He has several times been chairman of the B.R.E.M.A. and has also served on the council of the R.C.E.E.A. (now E.E.A.).



M. M. Macqueen

**D. W. Heightman, M.Brit.I.R.E.,** chief engineer of the Radio Rentals group since 1956, has been appointed to the board of Radio Rentals Ltd. as technical director. He was from 1951 to 1956 chief television engineer at the Liverpool works of the English Electric Co. Prior to joining English Electric he was on the board of Denco (Clacton) Ltd., which he formed in 1938.

**Lieut. P. Cave, A.M.I.E.E., R.N.,** who contributed an article on guided weapon techniques to our August, 1958, issue, writes in this issue on beam-riding. Lt. Cave, who is 35, started his technical career at the Post Office Research Station, Dollis Hill, where he was mainly employed on acoustical development work. This was followed by a short period at the laboratories of British Acoustic Films Ltd., before he entered the Electrical Branch of the Royal Navy in 1949.

**G. J. Pope**, author of the article on page 88 describing a transistor constant volume amplifier, is in the local lines branch of the Post Office Engineering Department, where he is concerned with the design of carrier receivers and amplifiers. He joined the Post Office soon after leaving the R.A.F. He is 35.

**P. Ransom, B.Sc.,** recently joined International Rectifier Co. (Gt. Britain) Ltd., as engineering manager. He was previously in the A.E.I. semiconductor research laboratories at Rugby. He joined the A.E.I. group in 1945 and since 1954 has been directly concerned with the development of power diodes.

V. G. P. Weake has relinquished his directorships of Pamphonic Reproducers Ltd., W. Bryan Savage Ltd., and Pye Marine Ltd., to become chairman of a new group of companies to be known as the Derritron Group. No details are yet available regarding the companies constituting this group. Mr. Weake, who is chairman of Audio Fairs Ltd. and of the recently formed Society of Environmental Engineers, is also a director of Eastern Nigeria Broadcasting Ltd.

G. S. Taylor, commercial director of Grundig (Great Britain) Ltd., which he joined on its formation in 1952, has been appointed chairman and managing director of the company in succession to the late A. E. Johnson (see "Obituary"). Mr. Taylor has also joined the board of Gas Purification and Chemicals Ltd., of which Grundig is a subsidiary.

J. F. Golding, contributor of the article in this issue on alignment equipment for mobile radio, started work in the test department of Marconi Instruments when he left school in 1936. During the early part of the war he joined the design department and, after the war, he spent a short period in technical sales and publicity. He then became a designer with E.M.I. Ltd., at Wells, Somerset, but five years ago returned to Marconi's as a technical writer.

## OBITUARY

Philip R. Coursey, B.Sc.(Eng.), M.I.E.E., F.Inst.P., F.Phys.Soc., at one time chief engineer and later technical director of the Dubilier Condenser Company, which he joined in 1923, died on January 3rd in his 68th year. In 1957 he retired from the position of technical director, which he had held since 1931, but remained on the board as an ordinary director and was retained by the company as technical consultant. He was educated at University College, London, where he became assistant to Sir Ambrose Fleming. During the first world war he was Admiralty Inspector of Wireless Telegraphy in H.M. Auxiliary Patrol, and in 1919 became technical research assistant at H.M. Signal School. From 1920 to 1923 he was assistant editor of *Radio Review* and research editor of *Wireless World* until 1925. He has contributed many fundamental articles to *Wireless World* and was the author of several books.

John R. (Jack) Binns, who, as mentioned by "Free Grid" last month, was the first ship's wireless operator to demonstrate the value of radio in saving life at sea, died in New York on December 8th, aged 75. Jack Binns, who was born in this country and was a Marconi operator from 1905 to 1912, had been associated with the Hazeltine Corporation since 1924. He was president in 1942 and chairman of the board from 1952. He was operator in the liner *Republic* when it was in collision in January, 1909, with the Italian vessel *Florida*. His wireless messages relayed by the American station at Nantucket Island resulted in the *Baltic* rescuing all the passengers on board the two ships. Medals were struck for the officers and crews of the three vessels, and Binns was the recipient, at the hand of the Marchese Marconi, of one of four struck in gold (the others went to the three captains).

Admiral Arthur J. L. Murray, C.B., D.S.O., O.B.E., at one time during the war Director of the Signal Department at the Admiralty, died on December 26th, aged 73. He was in command of the Signal School, Portsmouth, from 1937 to 1939. Admiral Murray was president of the British Wireless Dinner Club in 1952.

Albert E. Johnson, chairman and managing director of Grundig (Great Britain), Ltd., which he formed in 1952, died on November 25th after several months' illness. He was also a director of Gas Purification and Chemical Co., and a number of its subsidiaries. Mr. Johnson had been associated with the radio industry for over thirty years.

## NEW YEAR HONOURS

Sir George Nelson, chairman of the English Electric Co. and a number of companies within the group, including English Electric Valve, Marconi's W/T and Marconi Marine, is to be a Baron.

Lt. Gen. Sir Ian Jacob, K.B.E., C.B., Director-General of the B.B.C. from 1952 until the end of last year, and president of the European Broadcasting Union since its formation in 1950, is appointed a Knight Grand Cross of the Order of the British Empire (G.B.E.).

Robert J. P. Harvey, C.B., Deputy Director-General of the Post Office since 1955, and previously director of the Radio and Accommodation Dept., becomes a Knight Commander of the Order of the British Empire (K.B.E.).

Joseph F. Lockwood, chairman of Electric and Musical Industries and a director of the National Research Development Corp., receives a Knighthood.

Dr. Harrie S. W. Massey, F.R.S., Quain Professor of Physics at University College, London, and a member of the Radio Research Board, receives a Knighthood.

Among those appointed Commanders of the Order of the British Empire (C.B.E.) are: L. J. Davies, director of research and education, B.T.H. (now A.E.I., Rugby); D. C. Martin, assistant secretary, Royal Society; W. Stubbs, Director-General of Telecommunications, Malaya; F. Williams, controller of sound broadcasting engineering, B.B.C.

Newly appointed Officers of the Order of the British Empire (O.B.E.) include: F. E. B. Clark, Director of Posts & Telecommunications, Ghana; and A. W. H. Cole, manager, communications division, Marconi's W/T Co.

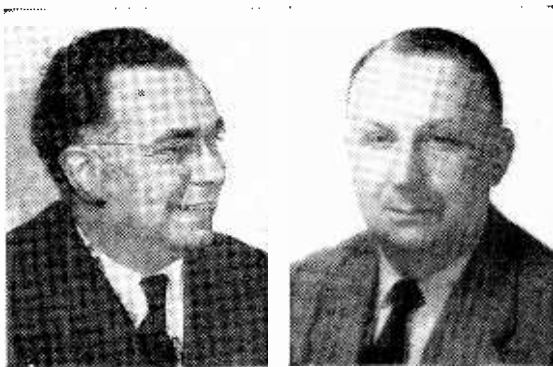

A. W. H. Cole (O.B.E.)

L. G. Fowell (M.B.E.)

The following are among the new M.B.E.s: A. Allen, chief development engineer, Cossor Radar and Electronics, Harlow; S. R. Brown, signals officer, Ministry of Aviation; F. N. Chadwick, higher executive officer, London Communications-Electronics Agency; R. W. Chandler, chief telecommunications supt., G.P.O.; A. Draper, vice-principal Rugby College of Engineering Technology; L. G. Fowell, executive engineer and general manager, Pye Ltd., West Drayton; M. H. Hall, engineer-in-charge, B.B.C. television studios; D. A. Hewetson, telecommunications technical officer, Ronaldsway Airport, Isle of Man; J. H. Kirk, executive engineer, G.P.O.; W. J. Marshall, senior executive engineer, Engineer-in-Chief's Office, G.P.O.; N. G. Payne, engineer-in-charge, I.T.A. station at Lichfield; and G. H. Prince, head of Apparatus Engineering Dept., Ericsson Telephones, Nottingham.

Recipients of the British Empire Medal include: J. Armitage, civilian instructor, R.A.F. Technical College, Henlow; F. A. Loomes, technical officer, Post Office Research Station; and J. N. N. Murray, civilian radio operator, War Office, Cyprus.



# Ionosphere Review 1959

## DECLINING SOLAR ACTIVITY

By T. W. BENNINGTON\*

**T**HE present cycle of solar activity reached its maximum at the epoch February/March, 1958, and since then the average activity, as evidenced by the twelve-month running average of the sunspot number, has been declining. Throughout 1959, however, the decrease in sunspot activity has been relatively slow, so that, at the end of the year, the running average sunspot number was still above 160, a value which is higher than that reached even at the maximum of any other solar cycle of which we have records. The year 1959 was, therefore, one of exceptionally high solar activity, and, consequently, a year during which the frequencies of use for long-distance communication remained particularly high.

**Course of the Sunspot Cycle.**—The graphs will give an idea of the present situation. In the upper graph are plotted the sunspot numbers (indicative of the degree of solar activity) from the minimum year of 1954 until the end of 1959, and in the two lower graphs the noon and midnight F2-layer critical frequencies as measured at the D.S.I.R. station at Slough (indicative of the level of F2 ionization) are given. The full lines in each graph give the monthly mean, or median, values and the dashed lines show the twelve-month running average of these, and so indicate the average conditions and the general variation in each quantity.

Since sunspot maximum early in 1958 there have been some large fluctuations in the monthly value of the sunspot number, but towards the end of 1959, lower values were reached than for some years past. The twelve-month running average has, during this period, shown an almost continuous, but generally slow, decrease.

The noon critical frequency was only slightly lower during the summer of 1959 than during that of 1958, but the winter values at the end of the year were considerably lower than at the beginning, and during 1958. The midnight critical frequency peaked during the summer at a higher value than during 1958, but towards the end of the year it, also, had reached values lower than those for the previous winter. The change in critical frequency since sunspot maximum has thus, on the average, been a rather slow decrease, as is shown by the dashed-line curves both for noon and midnight, and the implication is that, during the year, the frequencies of use for communications should have remained relatively high. In practice this was found to be so.

**Usable Frequencies.**—The highest broadcast frequency band of 26Mc/s remained usable over many daylight circuits throughout the year, and the 28-Mc/s amateur band, whilst very often above the m.u.f. during the summer months, became workable again in most directions during the autumn. The highest frequencies receivable over the North Atlantic circuits, which were of the order of 50Mc/s at the beginning of the year, decreased to about 26Mc/s during the summer, and increased again to about

44Mc/s during the autumn. The Crystal Palace sound channel (41.5Mc/s) was very frequently receivable in South Africa during March but such reception became rare in the period May to August. During the September to November period it became more frequent, but much less so than during March. The annual pattern for the ionospheric propagation of these high frequencies is thus that of good propagation of the highest frequencies at the beginning of the year, a big frequency decrease in the summer, and an autumnal increase to frequencies which, whilst relatively high, were considerably lower than those propagated at the beginning of the year.

**Ionospheric and Magnetic Disturbances.**—The magnetic and ionospheric data for 1959 show that the number of magnetically and ionospherically disturbed days was somewhat greater than during 1958. On the other hand the number of sudden ionospheric disturbances (which are associated with the occurrence of solar flares near sunspots) was slightly less than during the previous year. As the frequency of occurrence of sunspots and solar flares decreases during the next few years so is the number of sudden ionospheric disturbances likely to continue to decrease. The same is not true for magnetic and ionospheric storms, however, for, during the decreasing phase of the sunspot cycle, many of these are caused by corpuscles emitted from solar regions where there is no sunspot activity.

**The Coming Year.**—During 1960 it is probable that

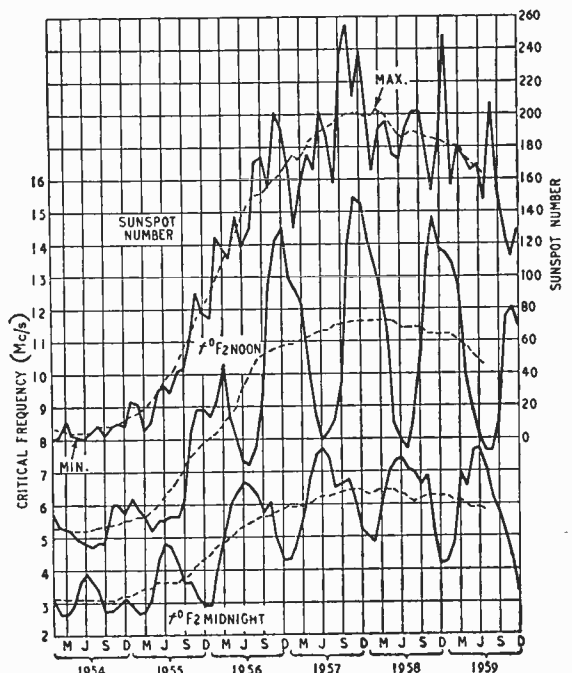

Variations in sunspot activity with corresponding variations in ionospheric conditions, 1954 to 1959.

\* Research Department, British Broadcasting Corporation

the solar activity will follow a slow decline, but at a somewhat greater rate than during 1959, and that the twelve-month running average sunspot number at the end of the year (applicable to the epoch June/July) will be somewhere in the region of 115. If this be so we may expect the higher daytime frequencies to remain usable until early summer, and then, following on the seasonal decrease which takes place at that time, for there to be a definite tendency for somewhat lower frequencies to be of more use during the autumn and winter, and for the higher frequencies to fail over certain circuits. For example, over North Atlantic circuits the 26-Mc/s broadcast band is unlikely to be usable after March, and

with the 17-Mc/s or even the 15-Mc/s band being best during the summer, the 21-Mc/s band is likely to be the highest usable from September onwards. For communication in more southerly directions the 26-Mc/s band may be usable at the end of the year as well as at the beginning, though during the summer the 21-Mc/s band is likely to be best. As to the night-time frequencies there is already a tendency towards more use of somewhat lower frequency bands, and, following on the summer frequency increase, this is likely to continue in the autumn, resulting in the greater use, over all circuits, of lower night-time frequencies at the end of the year than at the beginning.

## Demonstrating Electron Spin Resonance

A Simple Apparatus for Use in the Lecture Room

By G. B. CLAYTON,\* B.Sc.

THE techniques of nuclear magnetic resonance and electron spin resonance, both branches of radio-frequency spectroscopy, are now firmly established as research methods and are finding an increasing number of applications in many fields of science<sup>1</sup>. It would therefore seem desirable that the basic principle of the magnetic resonance effect, which is common to both n.m.r. and e.s.r., should be more widely known. The phenomenon may be demonstrated with modest apparatus; this article describes such an apparatus and gives a simple explanation of the effect.

The phenomenon of magnetic resonance is essentially a quantum mechanical effect, but its description in terms of classical mechanics is very instructive and leads to results that are in agreement with those found quantum mechanically. Nuclei and electrons

may be thought of as spinning particles having both charge and mass. Consider a spinning sphere having positive charge uniformly distributed over its surface (Fig. 1). The whirling charge on the surface of the sphere represents in effect a circulating electric current, which will produce a magnetic field. The spinning mass of the sphere will give it an angular momentum, so that we may think of the spinning charged sphere as acting in a sense like a flywheel with a bar magnet pointing along its axis.

Now consider this system placed in a steady magnetic field  $H$ , with the magnet inclined at some angle to the field (Fig. 2). The magnet will experience a torque tending to turn it into alignment with the magnetic field, but this will not take place because the magnet is attached to the flywheel. The torque acting on the angular momentum of the flywheel will cause the flywheel to precess about the direction of the magnetic field.

A mathematical treatment of the motion gives the relationship:

$$\omega = \gamma H \quad \dots \quad 1$$

for the angular velocity  $\omega$  at which the precession takes place.  $\gamma$  is a constant called the gyromagnetic ratio and is equal to the ratio

$$\frac{\text{angular momentum of particle}}{\text{magnetic moment of particle}}$$

A simple analogy for the effect may be found in the behaviour of a spinning top (Fig. 3). The weight of the top acting through its centre of gravity produces a torque tending to make it topple over, but because the top is spinning this torque actually causes it to precess, as shown in the sketch.

Return now to the system considered in Fig. 2 and imagine that, in addition to the steady magnetic field  $H$ , a second magnetic field  $H_1$  ( $H_1 \ll H$ ) is applied, and that this field is rotating in a plane at right angles to  $H$  with angular velocity  $\omega_1$  (Fig. 4). This rotating field will also produce a torque on the magnet, but if the field is rotating at a rate that differs appreciably from the rate at which the

Fig. 1. Spinning charged particle (a), producing a magnetic field (b), acting like a flywheel with an axial bar magnet (c).

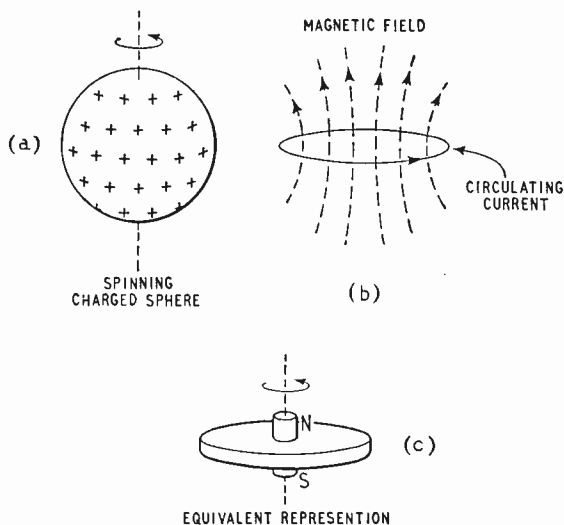

\* Liverpool College of Technology

magnet is precessing, the direction of the torque will be rapidly changing and its value will average to zero. In this case the rotating field will have no resultant effect. On the other hand, if  $H_1$  is rotating at the same rate as the magnet is precessing it will produce a steady torque on the magnet. This steady torque will cause the magnet to precess about  $H_1$ , while continuing in its precession about the steady field  $H$  (Fig. 5).

The result of this precession about  $H_1$  will be a change in the angle between the magnet and the steady field  $H$ . If the magnet was initially pointing in the direction of the steady field the rotating field would cause it to tip up and down; this tipping of the magnet represents the phenomenon of magnetic resonance.

The resonance condition is that the field  $H_1$  should rotate at the same rate that the magnet precesses about  $H$ , and is given by the equation

$$\omega_1 = \omega = \gamma H \quad \dots \quad 2$$

The energy of the magnet in the steady field  $H$  depends on the angle that it makes with this field. It will be a minimum when the magnet points in the same direction as  $H$  and a maximum when the magnet points in the opposite direction to  $H$ .

The magnet will thus absorb energy from the rotating field  $H_1$ , as it turns against the steady field  $H$  and will return this energy as it lines up with the steady

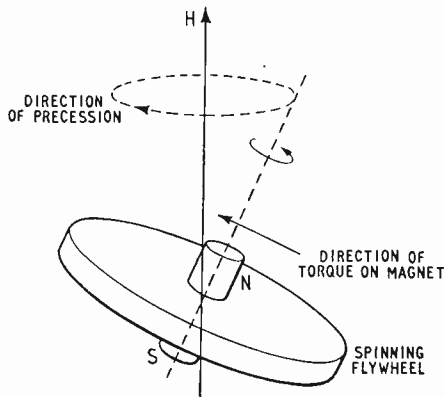

Fig. 2. The magnet-flywheel of Fig. 1 placed in a steady magnetic field.

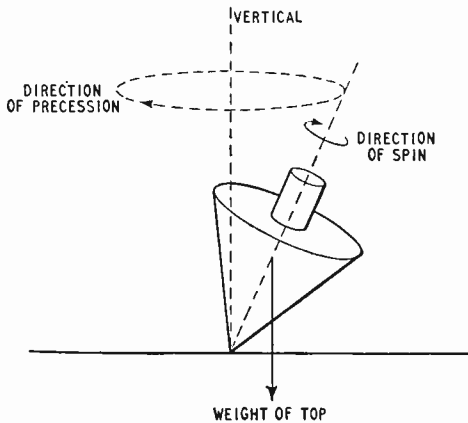

Fig. 3. Spinning top analogy for the action in Fig. 2.

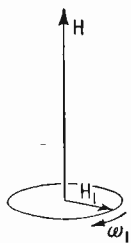

Fig. 4. Showing how the second magnetic field  $H_1$  rotates relative to  $H$ .

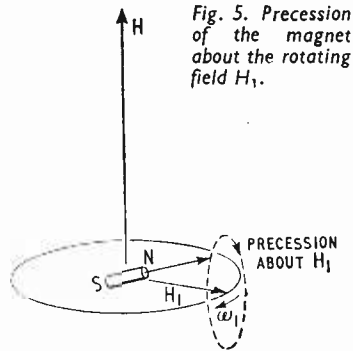

Fig. 5. Precession of the magnet about the rotating field  $H_1$ .

field. In a system containing a large number of such magnetic particles there will be a resultant absorption of energy from a small field rotating at the resonance frequency if there is always an excess number of particles pointing in the direction of the steady field. In practice this excess is initially established and then maintained as a result of energy exchange between the thermal vibrations of the material containing the particles and the magnetic energy of the particles.

The effect has been described for positive particles (e.g., protons). A similar treatment is appropriate for negatively charged particles (electrons). Values of constants substituted in eq.2 give for the resonant frequencies:

for proton resonance  $f(\text{kc/s}) 4.26H$  (oersteds)  
for electron resonance  $f(\text{Mc/s}) 2.80H$  (oersteds)

Nuclear magnetic resonance observations are usually carried out in a field of the order 10,000 oersteds, in which field the proton resonance takes place at 42.6Mc/s. Electron spin resonance observations are usually made in fields of the same order, making the resonant frequency lie in the microwave region.

In certain cases where a narrow absorption line is produced e.s.r. may be observed in quite small magnetic fields. For a field of 10 oersteds the resonance occurs at 28Mc/s. Observations of e.s.r. at these frequencies have been reported in metals<sup>2</sup>, in metal ammonia solutions<sup>3</sup>, and in organic free radicals<sup>4</sup>. The apparatus to be described has been used to observe the e.s.r. absorption arising from the unpaired electron spins in the organic free radical diphenyl-picryl hydrazyl.

Free radicals are formed when one of the covalent bonds in an organic molecule is broken. Each fragment takes with it one electron from this bond, and these fragments are called free radicals. The distinguishing feature of free radicals is that they have an unsaturated valency bond; that is, they have associated with them an electron whose spin and magnetic moment is not compensated by another electron with spin and magnetic moment pointing in the opposite direction. It is the presence of these uncompensated electrons that makes the observation of e.s.r. possible.

Free radicals, because of their unsaturated valency bond, are very reactive and are normally short lived. Diphenyl-picryl hydrazyl, the specimen used, is a substance that has an unsaturated valency bond, but it is quite stable. It is a crystalline solid and no difficulties are involved in handling it†.

† Diphenyl-picryl hydrazyl should be obtainable from any supplier of fine chemicals. The organic free radicals tri-p-anisyl-ammonium perchlorate, and tri-p-aminophenyl-ammonium perchlorate have also been reported as giving an absorption signal at the frequencies used and should be suitable for use in the apparatus.

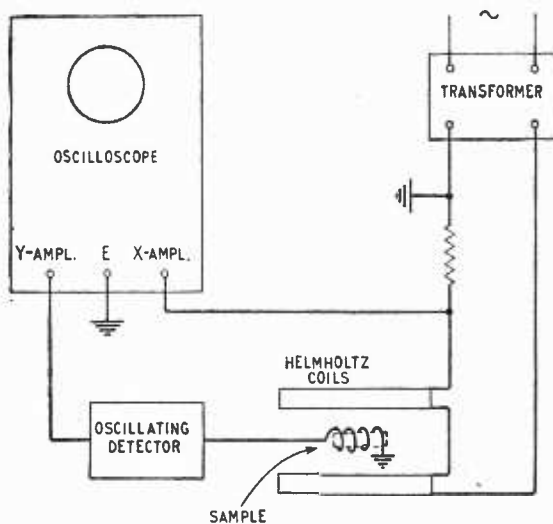

Fig. 6. Basis of the apparatus for demonstrating electron spin resonance.

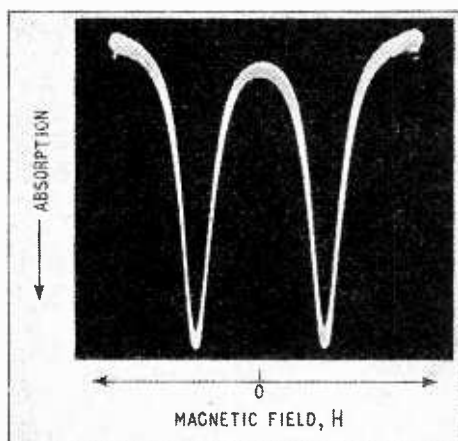

Fig. 7. Double absorption curve given by the oscilloscope in Fig. 6.

The apparatus consists essentially of an oscillating detector. The tank coil of this oscillator contains the specimen and is positioned at right angles to the magnetic field produced by a pair of Helmholtz coils. The oscillating magnetic field produced by the coil of the oscillator will, of course, be linearly polarized, but a linearly polarized field may be thought of as consisting of two fields rotating in opposite directions, and the effect of the component rotating in the opposite direction to the precessing spins is negligible. In order to observe the absorption the frequency of the oscillator is fixed and the magnetic field produced by the Helmholtz coils is swept through its resonance value. The detected output of the oscillator is made to produce a vertical deflection on an oscilloscope trace while the magnetic field sweep is used to produce the horizontal deflection (Fig. 6).

The current for the magnetic field sweep is supplied by a transformer connected to the 50-c/s mains. This a.c. sweep produces the double absorption hump shown in the oscillogram Fig. 7. The double hump in fact represents only one absorption line,

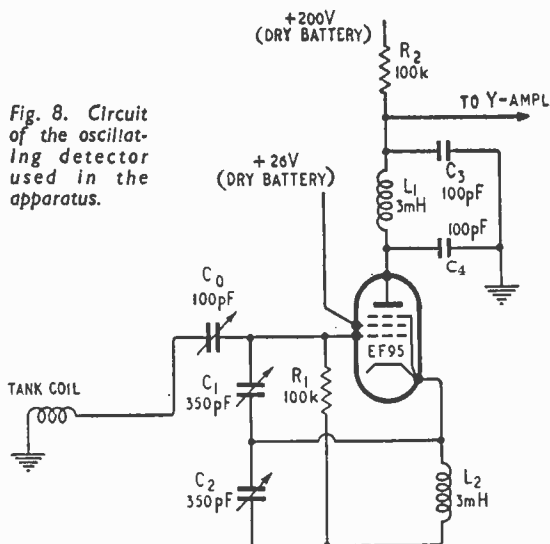

Fig. 8. Circuit of the oscillating detector used in the apparatus.

for the magnetic field is made to pass through its resonant value first in one direction and then in the opposite direction.

The circuit of the oscillating detector used is given in Fig. 8. It is a modified Clapp oscillator. Absorption by the specimen lowers the Q of the tank coil and produces a change in the level of oscillations which is detected by a change in the voltage across  $R_2$ . Approximately 1 gm of the diphenyl-picryl hydrazyl placed inside the oscillator tank coil has been found to give a change of 400mV in the voltage across  $R_2$  when the magnetic field is swept through its resonance value.

Radio frequency oscillations are eliminated from  $R_2$  by the filter  $C_3, L_1, C_4$ . Capacitors  $C_1, C_2$  are adjusted until oscillations just commence; the circuit is then most sensitive to changes in the Q of the resonant circuit.  $C_1$  is kept approximately equal to  $C_2$ .

There is nothing very critical about the design of the oscillator tank coil. It consists of several turns of enamelled copper wire wound on the  $\frac{1}{2}$ -in diameter tube containing the specimen. The coil is connected to the oscillator circuit by a short length of coaxial cable. Several coils were, in fact, wound to cover the frequency range 15 to 30Mc/s. Plywood formers, of diameter approximately 8in, were used for the Helmholtz coils, each being wound with 100 turns of No. 24 s.w.g. enamelled copper wire. An a.c. amplitude of 1 amp was found sufficient to sweep right through the resonance.

The apparatus described is comparatively simple and inexpensive, and the large and costly magnet normally used in magnetic resonance investigations is not required. It should be emphasized that the primary purpose of the apparatus is for the demonstration of magnetic resonance absorption. If it is required to detect very small absorptions or to study broad absorption lines it is necessary to work with much larger magnetic fields than can be produced with simple coils.

#### REFERENCES

- 1 "Spectroscopy at Radio and Microwave Frequencies," by D. J. E. Ingram, Butterworth (1955).
- 2 *Phys. Rev.*, **94**, (1954), p. 1067.
- 3 *J. Chem. Phys.*, **21**, (1953), p. 1429.
- 4 *Phys. Rev.*, **95**, (1954), p. 607.

# BEAM RIDING

By LIEUT. P. CAVE, A.M.I.E.E., R.N.

## PRINCIPLES OF RADIO GUIDANCE TECHNIQUE FOR MISSILES

**T**HE missile guidance system known as beam riding is a popular method for medium range missiles and has advantages over some other systems. It is used in modern weapons and probably its use will continue with longer range missiles even if it has to be combined with some other form of guidance for the latter stages of its flight to provide the necessary accuracy.

The system relies on the automatic centring of the missile in a radio beam, and hence the missile flight path may be controlled by moving the beam. In the simplest case the beam is pointed continuously at the target either manually or automatically and hence the missile will fly up the centre of the beam to the target. It will be seen that this guidance system is in two stages, viz.:—

1. Pointing the beam at the target.
2. Making the missile "ride the beam," i.e. follow the beam centre.

For short range missiles, e.g. air-to-air weapons such as FIREFLASH, the first step may be accom-

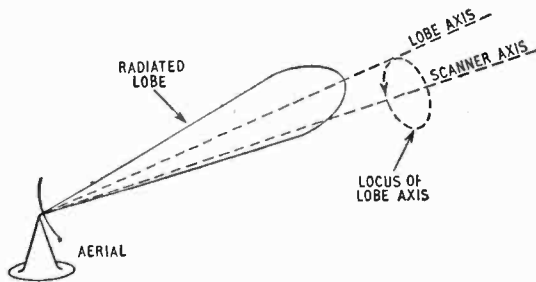

Fig. 1. Production of a conical scanning pattern.

plished by pointing the radio beam at the target using an optical sight. For longer range missiles it is necessary to establish the sight line by the use of a lock-and-follow radar. In theory it is not necessary to have any connection between the tracking radar and the radio beam other than that they must both point in the same direction. There is generally a close connection between the two transmissions from a viewpoint of mechanical and electrical convenience. For instance, to lock the aim of the two transmissions it is convenient to use the same radar aerial, and electrical synchronisation is necessary to overcome interference problems. In addition, there is a similarity between the method used to obtain the automatic following action and that used in riding the beam. To develop this idea further let us examine the working of a typical automatic following radar.

The most commonly used system is by conical scanning of the radar beam, but other methods that are used include "sequential lobing" and "simultaneous comparison" systems. In the conical scanning system the radar transmissions are focused into a pencil beam and this beam is offset from the axis of

the scanner by a fixed angle. If the beam is now rotated about the scanner axis it will trace out a conical pattern with the apex of the cone at the aerial as shown in Fig. 1.

Consider now the radar echo obtained from a target which is within the conical scan but displaced from the aerial reflector axis as shown at T in Fig. 2. Since the echo received by the radar depends on the misalignment between the centre of the radar lobe and the line of sight to the target, the echo received will vary as the lobe rotates according to the distance PT between the target T and the instantaneous position of the lobe centre P. The shorter this distance the greater the echo, reaching a maximum when the distance is zero, i.e. when the radar lobe is pointing directly at the target. In the case shown in Fig. 2 this distance does not fall to zero but is at a minimum when the centre of the lobe is at A. This is the instant of maximum echo and similarly a minimum echo is received as the lobe passes through B and PT is a maximum. Thus the echo strength will vary from a maximum to a minimum and return to a maximum once per revolution of the scanning lobe.

If a pulsed radar system is to be used, the output of the radar receiver will consist of a series of pulses, amplitude modulated at the conical scanning frequency. The depth of the modulation is approximately proportional to the error of the target from the reflector axis and especial note must be made of the condition when this error is zero. In this case the target is always displaced from the radar lobe by the same amount and hence the echo modulation is zero. Similarly the maximum modulation occurs when the target is on the circle formed by the focus of the centre of the rotating lobe.

Following the block diagram of a simple automatic following system as shown in Fig. 3, the echo modulation signal may be extracted from the radar receiver output by a filter tuned to the conical scanning frequency. In order to discriminate against unwanted echoes, the radar receiver must include a gated amplifier whose operation is controlled by the target range. The filter output signal contains two pieces of information, viz.: (a) its amplitude is proportional to the magnitude of the target misalign-

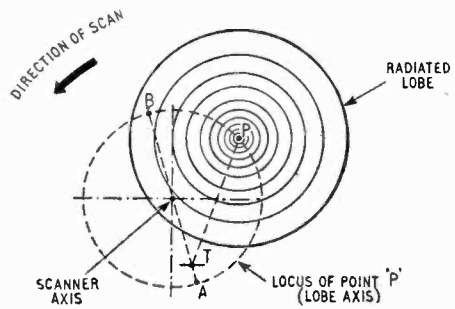

Fig. 2. Cross-section of a conical scan.

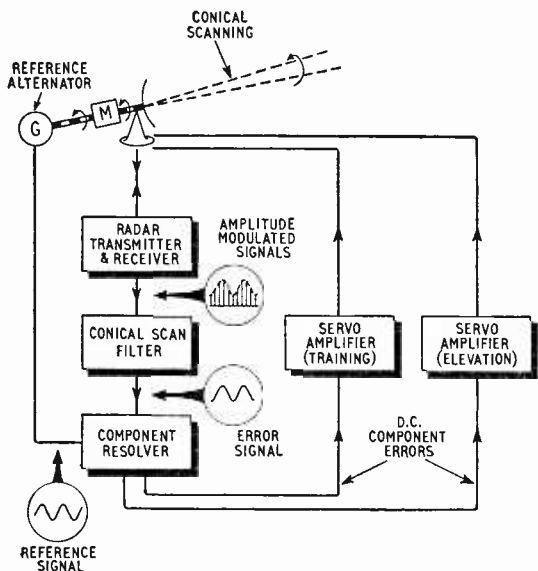

Fig. 3. Simple automatic following radar system.

ment; (b) its peak positive swing indicates the instant in the conical scanning cycle when the lobe sweeps closest to the target.

In order to correct the error in aim, the error along the target axis must now be resolved into component errors along the elevation and training axes of the aerial. In the same way that the target axis is defined by the peak in the error wave, so may the elevation (and hence training) axis be defined by the positive peak of a local reference signal. This is derived from a generator driven from the conical scanning motor and phased so that the positive peak of the generator output occurs as the radar lobe passes through the elevation axis. The phase angle between the reference and error signals is equal to the angle between the elevation and target axis as shown in Fig. 4.

The component errors in elevation and training are given by:—

$$\begin{aligned} \text{Training error} &= E \sin \phi \\ \text{Elevation error} &= E \cos \phi \end{aligned}$$

where  $E$  = peak value of error signal and  $\phi$  = phase of error signal with respect to the reference signal. These component errors are calculated in the resolver which may be of the resistance modulator or of the phase comparison variety. The outputs of the resolver are used to actuate the training and elevation motors via suitable amplifiers which in turn will be made up of a combination of an electronic amplifier and an electric amplifier such as a metadyne or amplidyne system. The polarity of the system is arranged so that the motors train and elevate the aerial in the correct direction.

It will be seen that the overall arrangement is a servo system whose input and output are the target and aerial positions respectively and where the radar and associated resolver form the error measuring device. The performance of this servo may be regulated by the usual servo devices, e.g. phase correcting networks. These are frequently incorporated into the amplifier section. Thus when the automatic following system is working correctly, we have the condition where the target lies on the scanner axis

whilst the beam performs a conical scan around it.

In order to guide the beam-riding missile, a separate conically scanning pulsed beam is radiated and aimed in the same direction as the automatic following beam. The missile is equipped with a receiver and rear pointing aerial capable of detecting the transmitted pulses when it has been launched into the conical scanning pattern.

In theory, there is no reason why the transmission used for the automatic following radar should not be used to guide the missile, but in practice several factors combine to make this undesirable and to give better results when separate beams are used.

The displacement of the missile from the beam centre will cause the missile receiver output to be amplitude modulated at the conical scanning frequency since the instantaneous output will be governed by the displacement of the missile from the centre of the lobe. An error signal may now be derived by detection of this amplitude modulation. The amplitude of the error signal will be indicative of the missile's displacement from the beam centre and the peak positive swing will indicate the instant when the lobe centre is closest to the missile. The production of this error signal is a close parallel to the case of the automatic following radar.

The majority of missiles use a Cartesian control system, i.e., they are controlled by four control surfaces, which, by operating in pairs, cause the missile to move in the pitch and yaw planes. Three further steps are necessary to bring the beam riding missile to the target axis.

(a) The error signal must be resolved into component errors along the radar vertical and horizontal axes.

(b) The missile must be stabilized in the roll plane in such a position that its pitch and yaw axes are in alignment with the radar vertical and horizontal axes throughout the flight.

(c) The control surfaces must be deflected by an amount proportional to the component errors in each case in the correct direction to accelerate the missile towards the centre of the beam.

In the case of the automatic following radar, resolution of the error signal was accomplished with the aid of a reference signal which defined the radar axes. To enable the same process to be used in the

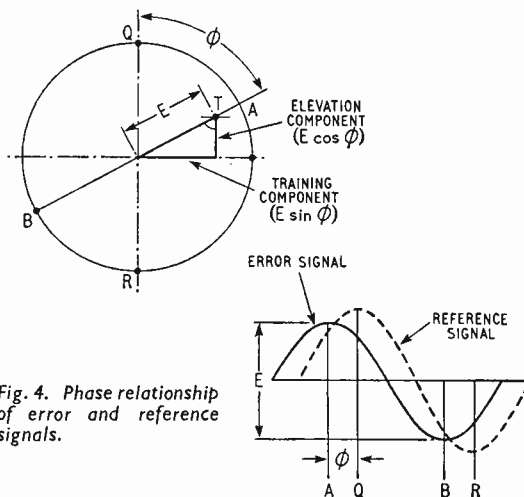

Fig. 4. Phase relationship of error and reference signals.

missile, the reference signal must be transmitted independently to the missile. Whilst this could be accomplished by the use of a separate radio link, a more reliable and less bulky method is to pulse-position-modulate the guiding beam with the reference signal, thus transmitting the reference signal to the missile without interference to the amplitude modulation/error signal process. This means that when the instantaneous value of the reference signal is positive the spacing between pulses of the guiding transmitter will be small and hence the pulse repetition frequency will rise, but when the signal is instantaneously negative, the spacing will be larger and hence the pulse repetition frequency will be lower.

In short, the reference wave is conveyed to the missile by a sinusoidal modulation of the pulse repetition frequency of the guiding transmitter. Reference to Fig. 5 will show that the output of the missile guidance receiver is taken to separate a.m. and f.m. detectors which produce the error and reference signals respectively. The signals are then fed to the resolver whose outputs are the pitch and yaw component error signals.

Another method whereby a reference may be produced in the missile is to rotate the plane of polarization of the guidance beam in step with the conical scan. The small dimension of the rectangular waveguide horn radiating the guiding transmitter signals is kept radial to the scanner axis whilst it is rotated. Hence the conical scan is produced simultaneously with the rotation of the plane of polarization and the instantaneous direction of the polarization (which is parallel to the small dimension of the waveguide) indicates the position of the lobe.

The direction of the polarization can be detected in the missile by the use of two aerials. One aerial is a circular waveguide horn which is not sensitive to the changing polarization. This will enable the amplitude modulation signal to be detected directly. The second aerial consists of a rectangular horn from which the received signal will vary as the polarization rotates and thus the reference signal will be produced. If this system is used, it is not essential to roll-position-stabilize the missile to keep it in line with the radar axes, since the reference signal is being produced with respect to the missile vertical as defined by the rectangular waveguide aerial. A disadvantage of this system is that the rotating plane of polarization introduces the problem of reflection of energy from the surface of the earth at low angles of elevation.

The overall accuracy requirement for a missile system, i.e., the maximum permissible miss distance, is determined by the effective range of the warhead, and the design of the guidance system must be governed by this parameter. For instance, for the beam riding missile to have a maximum miss distance of 150 feet at 20 miles range requires that it must not deviate from the line of sight from radar to target by more than four minutes of arc as measured at the radar aerial. The guidance accuracy is determined by two factors, viz:—

(1) The tracking accuracy of the automatic following radar, i.e., the maximum deviation of the scanner axis from the actual line of sight.

(2) The maximum deviation of the missile from the scanner axis.

In both cases the accuracy achieved depends on

the performance of a complicated servo system. The block diagram of the automatic following radar as shown in Fig. 3 has already been discussed; the diagram of the overall missile servo is shown in Fig. 6. In this servo the input, or required position, is the scanner axis as defined by the beam, whilst the output is the actual position of the missile. The missile receiver is the error measuring device and the error signal produced initiates movements of the control surfaces in such a direction as to correct the error and thus bring the missile position (output) into line with the scanner axis (input).

The performance of both servos will eventually be limited by the signal/noise ratio of the receivers, i.e., the minimum error signal that can be detected.

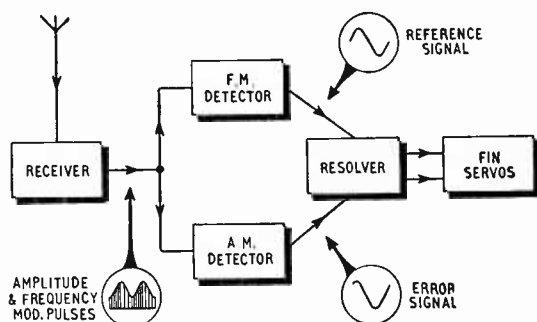

Fig. 5. Overall block diagram of control system in a beam riding missile.

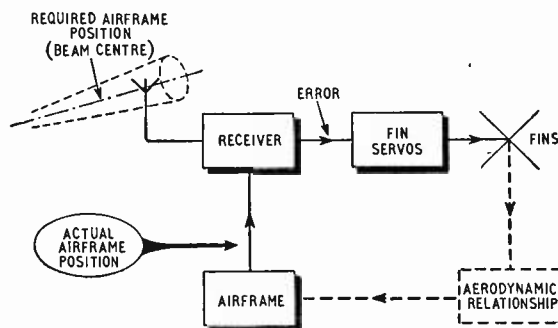

Fig. 6. The beam rider as a servomechanism.

Since the maximum signal is fixed at 100 per cent modulation of the pulse amplitude, corresponding to a missile or target located on the locus of the centre of the rotating beam, the minimum detectable error signal may be expressed as a fraction of the conical scanning angle. A figure of 1/20 will be used in this example. If the overall error of four minutes, referred to above, is split equally between the two servos (two minutes each), then the radius of the conical scan pattern must correspond to 40 minutes of arc, i.e.,  $\frac{2}{3}$  degree, and the total conical scan angle will be  $1\frac{1}{3}$  degrees.

Unfortunately it is not possible to launch the missile directly into this beam as the flight path of the missile when launched may differ by several degrees from the aim of the launcher. This is partly due to the low speed of the missile when leaving the launcher and to manufacturing tolerances in the air-

frame and propulsion system. In addition, it is not possible to design the aerodynamics of the missile so that it can be controlled at low speeds, and in most missiles the control system is not effective until the boost motor is exhausted and the missile is at full speed. As the missile thus travels for the first few seconds without control, movements of the target will cause the tracking beam to move and hence the missile may not be within the guiding beam when the control system is energized.

The launching errors may be summarized as (a) predictable—such as wind effects and target movement, and (b) unpredictable—covering manufacturing tolerances. Where the errors can be predicted a computer can be used to “aim off” the launcher to correct the missile’s flight path, but for unpredictable errors the method generally adopted is to use a wide-angle, low-accuracy beam whose conical-scan angle is wide enough to cover all possible firing dispersions. This beam must be identical to the narrow-angle high-accuracy beam in lobe position, scanner axis and reference transmission, so that the missile may be smoothly transferred from one beam to the other when it comes into the coverage of the narrow beam. The problem of reflections from the ground denies the system designer the chance of dealing with both predictable and unpredictable errors by this means as the conical scan required to do this would be very large.

It was mentioned earlier that roll stabilization was used to keep the missile axes in alignment with the radar axes, and although the roll gyro can have negligible wander during the time of flight, it is possible for the two sets of axes to become misaligned. This can be due to a variety of reasons, but assuming that the axes are aligned when the missile is launched, the main cause of error is due to the fact that whilst the roll gyro axis is stationary in space, the radar vertical direction will change as the aerial trains away from the launching bearing in order to follow the target. This effect is illustrated in Fig. 7. The result of this error, as shown in Fig. 8, is to cause the missile to fly in a spiral path to the beam centre instead of in a straight line. This occurs because the steering orders are derived with respect to the radar

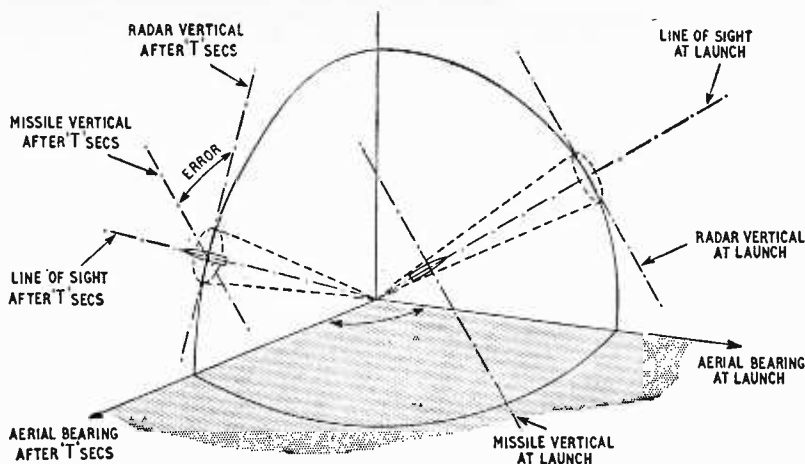

Fig. 7. Three-dimensional diagram showing change of radar vertical with aerial bearing.

vertical (as defined in the missile by the reference signal) but executed with respect to the missile vertical.

The inherent time lag in the missile response will now permit the missile to fly in the direction determined by its own axes before the modified steering orders generated by the guidance receiver can be effected, and hence the spiral trajectory depends on the stiffness of the overall missile servo as well as on the misalignment of the axes.

As this error occurs after launching, modification of the missile vertical would necessitate extra radio command signals to the missile to initiate precession of the gyro, and this is inconvenient as well as increasing the amount of equipment carried in the missile. Since the radar vertical is defined in the missile by the positive peak of the reference signal the apparent position of the radar vertical may be changed by altering the phase of the reference signal, i.e., by varying the point in the conical scanning cycle at which the positive peak occurs. The axis misalignment is computed at the launcher and the phase of the reference signal as transmitted by the guiding beams is corrected by the amount of the computed misalignment. This correction is most important since not only does this error reduce the missile range but the stability of the overall missile servo is affected and loss of control can easily result.

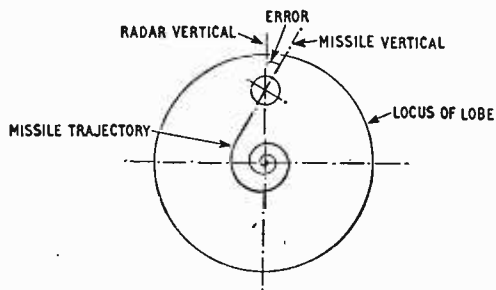

Fig. 8. Cross-section of beam showing spiral trajectory due to misalignment of verticals.

## Broadcasting Stations Guide

THERE are now well over 1,000 v.h.f. sound broadcasting stations in Europe and most of these are listed in order of frequency in the 12th edition of our book “Guide to Broadcasting Stations” just published. This edition, which has been completely revised, also lists all the major television stations on the Continent as well as giving operating characteristics of Europe’s long- and medium-wave stations and over 2,000 short-wave broadcasting stations of the world. The long-, medium- and short-wave stations are listed both geographically and in order of frequency.

Also included in the 112 pages of this enlarged edition, costing 3s 6d, is standard time throughout the world, international allocation of call signs, a wavelength-frequency conversion table and other useful information for the broadcast listener.



# Mobile-Receiver Alignment Equipment

DEVELOPMENT OF SPECIAL SIGNAL

GENERATORS

By J. F. GOLDING\*

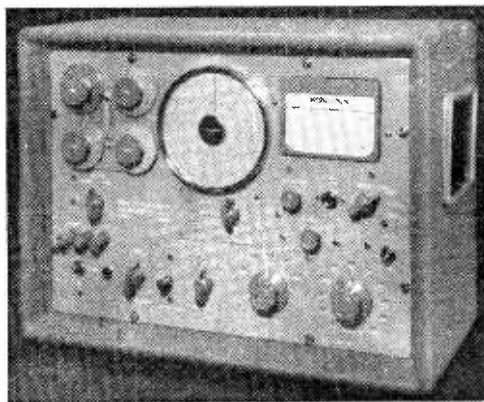

Marconi Instruments Type TF995A/5 f.m./a.m. signal generator.

**T**HE primary problem arising from the continuing increase in the number of mobile-radio operators is that of congestion of the available bands of frequencies. Two possible solutions to this problem are the reduction of channel spacing and the use of hitherto unallocated frequency bands. Both of these solutions are being exploited; the allocated frequency bands and the specified channel spacings in Great Britain and the United States are shown in Tables I and II respectively.

**TABLE I**  
Mobile-radio Frequency Allocations in Great Britain

Classification	Frequencies (Mc/s)	Channel Spacing (kc/s)
General Land Mobile (low band v.h.f.)	71.5-72.8	25
	76.95-78.0	25
	85.0-86.7	25
	86.95-88.0	25
Police, Fire, Ambulance	80.0-84.0	100
	95.0-100.0	100
Marine v.h.f.	156.0-165.0	50
General Land Mobile (high band v.h.f.)	165.0-173.0	50
General Land Mobile (u.h.f.)	460.0-470.0	100

**TABLE II**  
Mobile-radio Frequency Allocations in the U.S.A.

Classification	Frequencies (Mc/s)	Channel Spacing (kc/s)
Land Mobile (low band v.h.f.)	27.51-28.0	40
	29.71-49.98	40
Land Mobile (high band v.h.f.)	152.03-156.21	60
	157.53-161.79	60
Marine v.h.f.	156.3-157.4	50
	161.9 and 162.0	—
Land Mobile (low band u.h.f.)	452.05-459.95	100
Land Mobile (high band u.h.f.)	890.0-960.0	—

In Great Britain all land-based mobile systems, with the exception of certain of the police forces, employ amplitude modulation. Marine (ship-borne) radio uses frequency modulation, and aero-

\* Marconi Instruments Ltd., St. Albans.

nautical mobile radio uses a.m.—both by international agreement. In most other countries frequency modulation predominates for all mobile radio except, of course, aeronautical.

It is outside the scope of this article to discuss the merits and demerits of either type of modulation. Indeed, it has become evident that the type of modulation used has very little effect on the special requirements of the mobile receiver as they affect the signal generator design. These special requirements appear as secondary problems arising from the steps taken to overcome the primary problem of congestion.

The most important special requirement is that of adequate suppression of adjacent-channel interference. A mobile station may well be operating physically close to a transmitter of some other system; and unless there is sufficiently good rejection of the strong signal from this transmitter, the wanted signal may be masked by interference. At the same time it is obvious that the receiver bandwidth must accommodate not only the modulated signal; but also the combined permitted drift of the receiver and transmitter.

The narrow receiver bandwidth mandatory to close channel spacing produces a further requirement for accurate tuning and high stability, a requirement which is met by using crystal-controlled local oscillators. Most mobile receivers are of the double-superheterodyne type using a comparatively low second intermediate frequency; so there is little likelihood of drift in the i.f. amplifier causing any appreciable change in the tuning frequency of the receiver. Nevertheless, the i.f. amplifier must be accurately aligned to the correct frequency: the reason for this will be pointed out later.

These requirements have two common effects on the design of signal generators; a very high order of stability is required, and the output must be free from unwanted modulation—either a.m. or f.m. Very naturally, the purpose of the signal generator also influences its design to a considerable degree; and, in this connection, signal generators can be divided into two main categories—those intended for routine maintenance and service, and the more elaborate instrument intended for acceptance tests and design measurements.

Of the second category the most stringent requirements are those introduced to produce a signal

generator capable of measuring adjacent-channel rejection. For this reason the method of measurement is outlined together with a brief description of a suitable signal generator.

### Adjacent-channel Rejection Measurements

Assuming that the stability of a f.m. mobile-radio system is the same as that of its a.m. counterpart, the inherently lower sensitivity of the f.m. receiver to adjacent-channel interference is largely offset by its necessarily wider bandwidth. In practice, it has been found that similar adjacent-channel-rejection

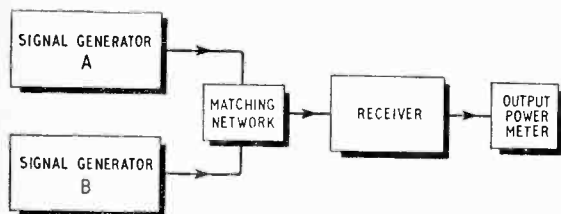

Fig. 1 Block schematic diagram of two-signal method of measurement of adjacent-channel-rejection ratio.

performance can be expected for the two types of modulation. For this reason the requirements laid down by the G.P.O. in the U.K. can be regarded as being largely representative of common practice in congested areas throughout the world.

**Single-signal Method of Measurement.**—Originally the rejection ratio was determined by plotting the frequency-response characteristic of the receiver using a single signal generator and comparing the response at the centre of the acceptance band with the response at the centre of the adjacent channel. But the figures obtained in this way are not very realistic; for, when the receiver is in the presence of a strong unwanted signal—such as that produced by a nearby transmitter of another system—the early stages of the receiver may become overloaded. Receiver “blocking” can reduce sensitivity whilst not altering materially the noise level so giving an effect similar to a weak signal and poor signal-to-noise ratio. Thus the interference actually produced can be worse than is indicated by the single-signal response measurement.

**Two-signal Method.**—A standard method of measurement has been evolved: this uses two signal generators. The output of one signal generator represents the wanted signal and that of the other represents the interfering signal. The two signal generators are connected, via a matching network, to the input of the receiver as shown in Fig. 1. Signal generator “A” delivering the “wanted” signal, is tuned to the centre frequency of the receiver’s acceptance band. Signal generator “B” is set to a frequency separated from that of “A” by slightly less than the channel spacing. A predetermined level of modulation is applied to both signals—either a.m. or f.m. as appropriate—a different modulating audio frequency being used for each of the signal generators in order that the wanted component may be distinguished from the interference component in the receiver’s output.

With the output of signal generator “B” reduced to zero, the output of signal generator “A” is adjusted to give a signal-to-noise ratio of 10 dB. The

output level of “B” is then increased until the signal-to-noise ratio is reduced by 3 dB, the interference breakthrough from signal generator “B” being deemed part of the noise. The adjacent-channel-rejection ratio is then equal to the ratio of the output levels of the two signal generators.

This is the method of test approved by the G.P.O. for mobile receivers: a rejection ratio of 70 dB<sup>1</sup> is required.

**Signal Generator.**—Until recently, much difficulty was experienced in making this type of measurement at v.h.f. due to the impure outputs of available signal generators. It is not difficult to appreciate that, if the output of signal generator “B” contains components within the ideal acceptance band of the receiver, the rejection ratio will appear to be less than the true figure. So it is important that the suppression of any such components should not be less than the required rejection ratio of the receiver.

These unwanted components are caused in various ways. Random noise may originate in the oscillator or subsequent stages of the signal generator. If amplitude modulation is used, harmonic distortion of the modulating waveform may produce high-order sidebands outside the channel bandwidth. Such sidebands can also be caused by microphony, which effectively produces both a.m. and f.m.

Good short-term stability is also essential. Although the carrier frequencies are in the v.h.f. range, it is necessary to maintain the tuning to within a few per cent of the channel width. In other words, for reliable measurement, facility for tuning in small increments with an accuracy of a few hundred c/s is necessary. So it is evident that, at the higher frequencies used, the maximum drift that can be tolerated is of the order of 0.0025% of the carrier frequency during the time taken to make a measurement—say 10 min.

These essential requirements for high stability and purity are, in general, not met by the standard type of v.h.f. signal generator. Therefore Marconi Instruments, Ltd., developed a special narrow-deviation version of their f.m./a.m. signal generator—type TF 995A/5—which is suitable for these acceptance tests and laboratory measurements on mobile receivers. This signal generator and the problems that led to its development are described in some detail elsewhere<sup>2, 3</sup>. It is a signal generator of the type employing a single-range oscillator followed by a series of harmonic-multiplier stages. The basic electrical arrangement of both signal generators is shown in Fig. 2.

There are several v.h.f. signal generators of this basic form available, a form which is very suitable for general v.h.f. work. Not only does the arrangement permit the use of the reactance-valve type of frequency modulator; also, due to the application of amplitude modulation to an output stage which is virtually isolated from the oscillator, an a.m. signal can be produced which is sensibly free from f.m. Furthermore, the frequency modulator of an f.m. signal generator offers a convenient means of providing a calibrated fine frequency control by the application of a variable direct-potential bias.

The TF 995A/5 signal generator employs a variable oscillator covering the frequency range 4.5 to 9.16 Mc/s. This is followed by a frequency-treble stage and three doubler stages in cascade. Range switching is accomplished by selecting the output of the appropriate multiplier and feeding it to the

resistive output attenuator. These stages produce four 2:1 frequency ranges covering from 13.5 Mc/s to 216 Mc/s, and an i.f. range covering 1.5 Mc/s to 13.5 Mc/s is provided by beating the output from the first doubler stage with that of a fixed frequency 30-Mc/s oscillator.

A very high order of frequency stability is another requirement; this has been met by the use of temperature-compensated components and the drift has been reduced to 0.002% in a 10-min interval.

Random noise in the r.f. oscillator is inversely proportional to the Q of its tuned circuit. This is inevitably reduced to some extent by the loading of the reactance valve. However, the maximum deviation required for mobile-radio use is 15 kc/s, compared with 75 kc/s for general purpose use; and advantage has been taken of this reduction in maximum deviation to reduce the coupling between the reactance valve and the oscillator, so achieving an improvement in circuit Q. This improvement, together with the use of low-noise valves, has reduced the random noise to a level well below the maximum permissible.

The instrument is equipped with a special directly calibrated incremental-tuning arrangement comprising a switched potentiometer for coarse adjustment of frequency and a continuously variable fine control. There is also an uncalibrated fine-tuning

control which varies the screen-grid potential of the oscillator itself. This control enables the operator to tune accurately to the centre frequency of a receiver's acceptance band with the incremental tuning controls set to zero. A simplified diagram of the tuning arrangements is shown in Fig. 3.

These facilities are of considerable importance when the instrument is used for the two-signal method of measurement. In order to tune the signal generator to the "interference" or adjacent channel frequency, the operator first tunes accurately to the receiver frequency and then changes the signal generator frequency by the specified separation, using the calibrated incremental controls. This would be very difficult without the special incremental tuning system.

In order to meet the requirement that the "interference" signal should be modulated at a different audio frequency from the "wanted" signal, the Marconi TF 995A/5 gives the choice of three switch-selected modulating frequencies. Attention has been given to the purity of the modulating waveforms to prevent high-order sidebands on a.m. and the f.m. content is naturally very small.

### General Maintenance of Mobile Receivers

In signal generators for the general maintenance of mobile receivers the requirement for a high-

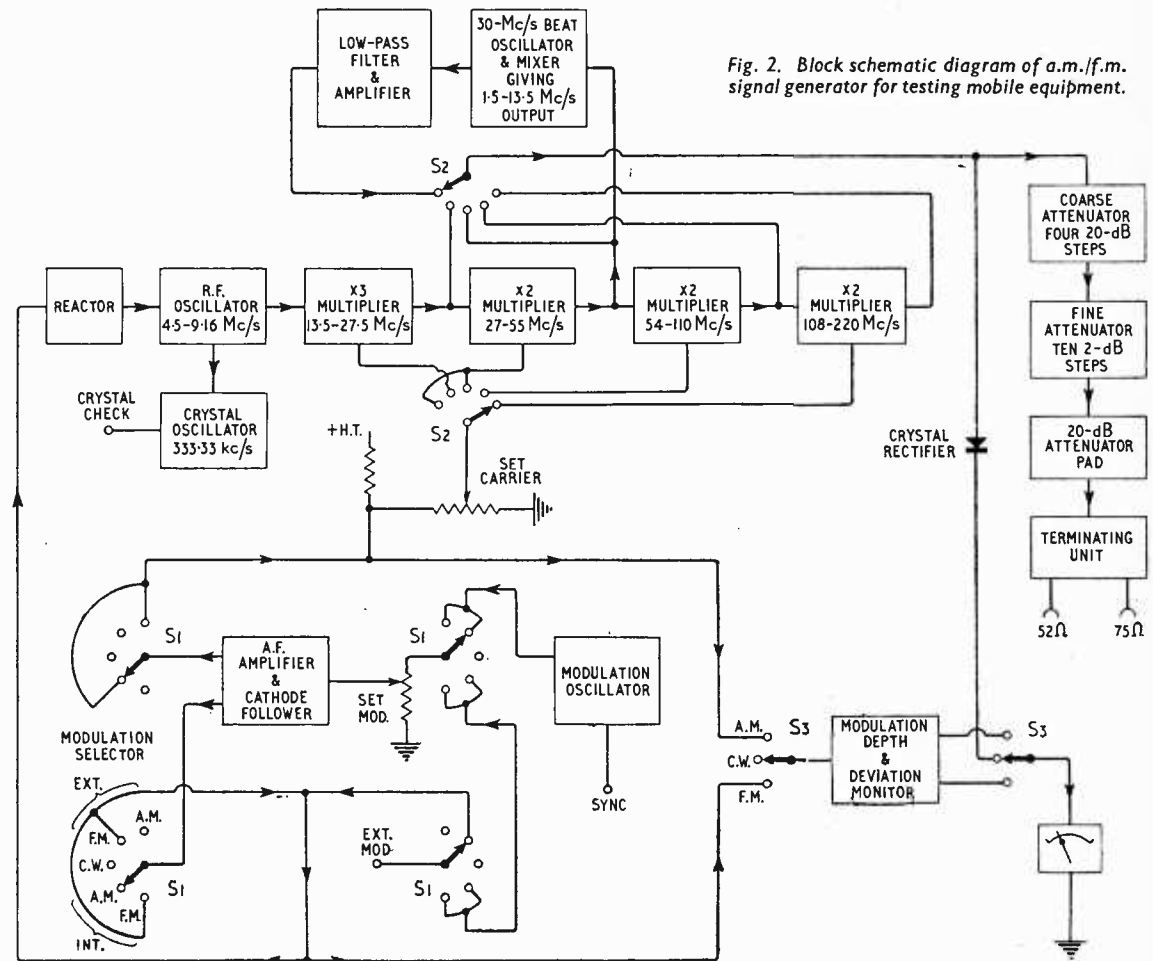
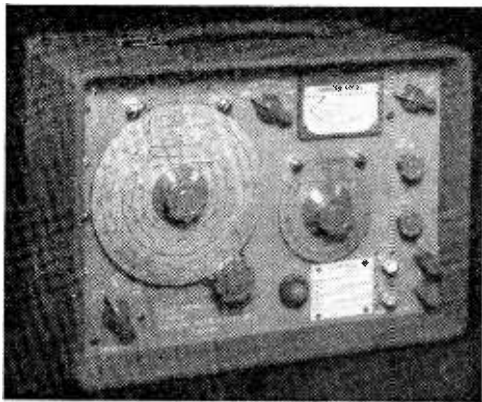

Fig. 2. Block schematic diagram of a.m./f.m. signal generator for testing mobile equipment.



Marconi Instruments signal generator Type TF 1064/2 for the servicing of mobile receivers.

purity output is rather less stringent than for the acceptance-test type of instrument. The necessity for high stability, however, remains. For general maintenance purposes the operator of mobile radio equipment requires a rather simpler and less expensive signal generator than that used for acceptance tests, so that the demand is for an economically-priced instrument with the special features necessary for the testing of narrow-band mobile receivers.

It is well known that high stability can be achieved in a restricted-range variable-frequency oscillator which has no switched r.f. connections i.e. the tuned inductor is soldered directly to the tuning capacitor. Accordingly, several manufacturers have adopted the principle of producing a series of single-range signal generators, each covering a narrow band of frequencies. This principle is particularly applicable to mobile-radio servicing owing to the allocation of discrete, comparatively-narrow frequency bands for this type of communication.

The development of the ferrite modulator and semiconductor techniques for frequency modulation has permitted the direct generation of f.m. signals at u.h.f. and v.h.f. without the use of frequency-multiplier stages. The design of these single-range signal generators is thus simplified with consequent reduction in cost.

An aspect of the alignment of mobile receivers which requires particular attention is the precise tuning of the i.f. amplifier. For, with crystal-controlled local oscillators, the correct tuning of the receiver ultimately depends on the tuning of the i.f. amplifier. There is, therefore, a distinct advantage in the use of a crystal-controlled test oscillator for i.f. alignment.

A crystal-controlled oscillator operating at the i.f. also provides an extremely convenient means of accurately setting the signal generator to the correct centre frequency of the receiver's acceptance band, even though the receiver may be misaligned so that this does not correspond to maximum response. The output of the signal generator is

applied to the aerial-input socket of the receiver in the usual way; and the output of the crystal-controlled test oscillator is loosely coupled to the i.f. amplifier. When the signal generator is accurately tuned to the receiver, the i.f. signal due to the r.f. input passing through the frequency changers beats with the loosely coupled i.f. test signal to produce an audible note in the receiver's loudspeaker (with f.m. receivers, the limiter is seldom good enough to suppress this beat note completely). Adjustment of the signal generator tuning for zero beat gives a maximum possible tuning error equal to the combined maximum errors of the crystal-controlled test oscillator and the crystal-controlled local oscillators of the receiver.

**Catering for Several Bands.**—Where various different mobile systems are serviced in the same establishment these single-range instruments are somewhat inadequate, and there is a demand for an inexpensive signal generator which possesses the necessary stability and covers a number of mobile-radio bands. Such an instrument is virtually a combination of several narrow-range signal generators housed in the same case and, of course, utilizing some common components.

The Marconi v.h.f. signal generators of the TF 1064 series conform to this description; they also include built-in crystal-controlled i.f. test oscillators. These instruments, which are basically similar, have three separate and independent r.f. oscillators covering respectively the high and low v.h.f. bands and the low (450 to 470 Mc/s) u.h.f. band. The electrical arrangement is shown in Fig. 4. This instrument is described in detail in an article by its designer<sup>4</sup>.

Each of the two v.h.f. ranges is covered by a fundamental-frequency oscillator using half of a double-triode valve. Frequency modulation and incremental frequency shift are achieved by a ferrite modulator which is common to the two ranges.

The u.h.f. signal is derived from a frequency trebler. It has been found that the frequency sta-

*(Continued on page 79)*

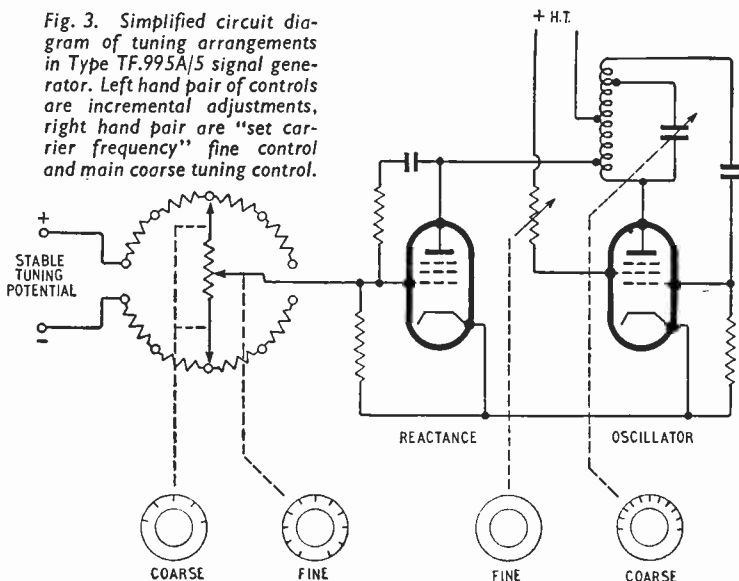

Fig. 3. Simplified circuit diagram of tuning arrangements in Type TF.995A/5 signal generator. Left hand pair of controls are incremental adjustments, right hand pair are "set carrier frequency" fine control and main coarse tuning control.

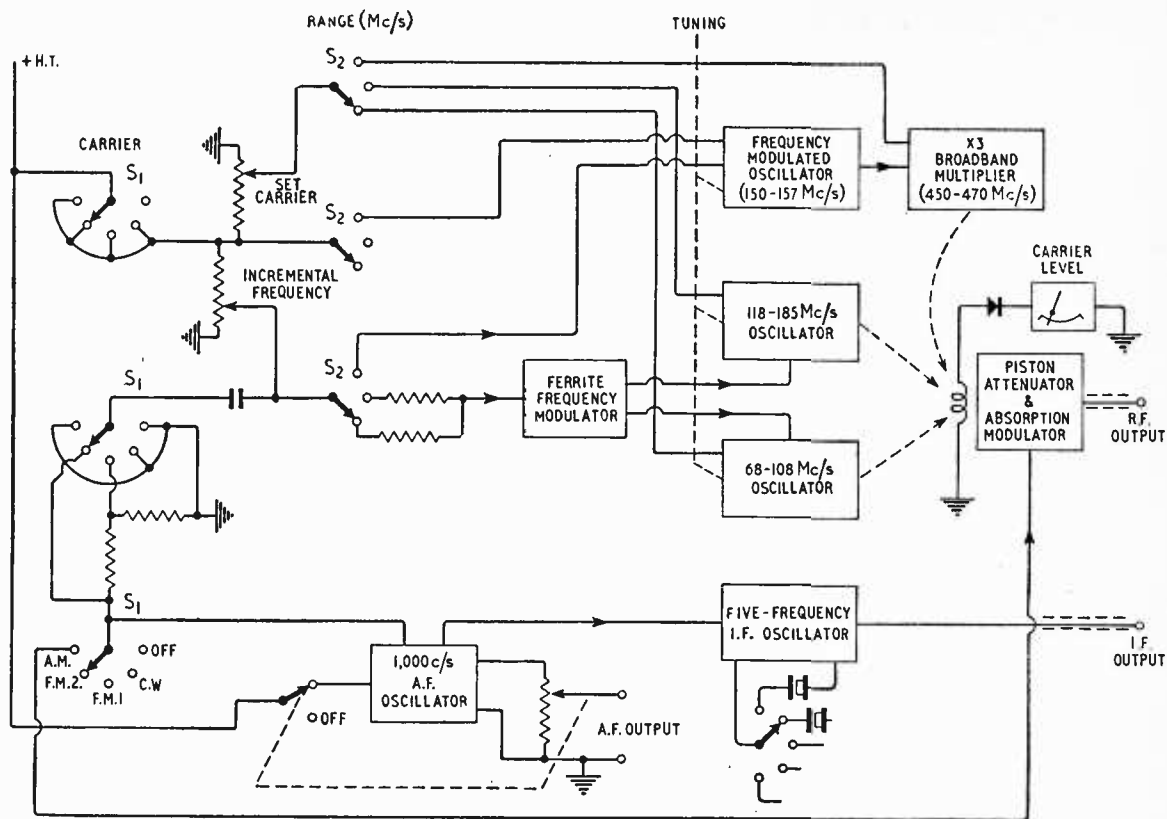

Fig. 4. Block schematic diagram of special signal generator for checking of mobile-radio receivers.

bility of lumped-circuit oscillators is generally poor at frequencies much above 200 Mc/s: for this reason, the u.h.f. range operates from an oscillator covering the band 150 Mc/s to 156.7 Mc/s. This oscillator feeds a double-triode push-pull trebler with a low-Q broad-band fixed-tune anode circuit. Frequency modulation and incremental frequency shift are produced by anode modulation of the oscillator valve and the limiting action of the trebler eliminates the small a.m. component.

The three sections of a standard three-gang variable capacitor act as tuning capacitors for the three oscillators. The outputs of the three sources are applied to a common piston attenuator. Frequency-range changing is achieved by the switching of the h.t. supply to the oscillator covering the selected range.

The crystal-controlled i.f. test oscillator is a completely separate unit housed in the same case. A switch selects any one of five crystals; these crystals fit into sockets at the rear of the instrument, the actual crystal frequencies being predetermined to suit the operational equipment with which the signal generator is to be used.

### Future Developments

The special signal-generator techniques that are being developed for mobile-receiver testing illustrate one aspect of the continuous demand for new types of test gear as progress is made in the operational equipment.

In the U.S.A. mobile-radio frequency allocations have been made in the 890-Mc/s to 960-Mc/s band.

At these frequencies, the signal-generator technique is noticeably different from that at low frequencies. The lumped-circuit type of oscillator is not very satisfactory; and signal generators tend to be rather elaborate mechanically, utilizing resonant-line oscillators and special valves.

### REFERENCES

1. G.P.O. Specification W6187, W6188 and W6130.
2. "An F.M./A.M. Signal Generator Specially Designed for Testing Mobile Radio Equipment," by J. C. Hill, *Marconi Instrumentation*, Vol. 6, No. 7, p. 187.
3. "Signal Generator Design Occasioned by Mobile Radio Services Expansion," by L. R. Head, *Marconi Instrumentation*, Vol. 6, No. 8, p. 228.
4. "New Test Equipment for Mobile Radio," by J. M. Parkyn, *Marconi Instrumentation*, Vol. 5, No. 8, p. 201.

### BATTERY SUBSTITUTE

IN *Murphy News* for December 1959 D. Lee describes the "battery substitute" or power supply which Murphy Radio Ltd. use for production tests on transistor receivers. To avoid damage should the output be short-circuited a current limiter is incorporated in the compound-emitter-follower output stage. The limiter consists of a resistor in series with the emitter of one output transistor, and a junction diode joins the "output side" of this resistor and the transistor base. If a large current is drawn the p.d. across the diode causes it to conduct: this "freezes" the base/emitter potential, so limiting the output current to a safe value. Also the high resistance of a run-down battery may be stimulated by a series resistor.

# LETTERS TO THE EDITOR

The Editor does not necessarily endorse the opinions expressed by his correspondents

## "Wien Bridge Oscillators"

MR. HICKMAN'S treatment (December 1959 issue) is almost perfect so far as it goes, but I fear he has based his article upon experience of building a fixed-frequency oscillator possibly with power from d.c. sources. Having for my own interest once built an a.f. oscillator, admittedly of the phase shift type, covering 5-100,000c/s, I feel he might well issue a warning and general advice.

The same basic problems of avoiding unwanted phase shifts and spurious couplings arise, as well as the desirability of feeding the frequency-determining networks from low-impedance sources. Attention seems to be called for to these matters.

(1) Power supply. Ripple or heater leakage, etc., can lead to interaction at 50c/s and harmonics.

(2) Power supply. Impedance of h.t. source can cause serious trouble, and even at 50c/s a regulated source seems desirable if variable frequency working is called for.

(3) Coupling of amplifier to Wien Bridge. This capacitor obviously has its influence by introducing a phase shift. Over wide-range working it will need to be switched, because otherwise the effect of capacity to earth will be important. For precision work electrolytics are out, so size becomes physically troublesome.

(4) Other stray capacitance and loading effects, mainly at the h.f. end, call for the lowest possible circuit impedances and cathode follower output, but this of course aggravates (3).

In my case I used 1% tolerance switched capacitors for hand switching, with variable resistance for fine control in steps of 1, 3 and 10. It was not possible to obtain accurate scale matching for each range without considerable attention to the above matters, and, in fact, unless one is content with a frequency accuracy of 5% at the extremes, it is ridiculous to rely upon accuracy of bridge components. C.R.O. checking is required, but this breaks down rather beyond a few kc/s owing to the difficulty of determining the multiple of 50c/s in question. Probably the best system is a circular display from 50c/s with grid brightening from the oscillator, but an auxiliary oscillator is called for to work beyond a few kc/s to the 100kc/s mark. Such methods, carefully used of course, are good to 0.1%, which is no doubt your contributor's goal, but they do show up no end of imperfections in the design. Incidentally, before I am attacked I would point out that I know well that variable resistance control has its own problems since the potentiometers must be wire-wound components possessing by no means negligible inductance and stray capacitances. The alternative of variable condensers and switched resistances for range multiplying leads to high circuit impedance and hum pick-up. It seems to be a case of finding the lesser evil!

London, N.W.11.

L. STREATFIELD.

### The author comments:

I am most grateful to Mr. L. Streatfield for the points which he raises in connection with, in particular, the difficulties associated with the design of Wien bridge oscillators to cover wide frequency ranges. Such considerations should certainly be borne in mind when dealing with variable frequencies.

With regard to power supplies, I would agree that good stabilization and freedom from hum are certainly desirable qualities, but may I point out that the effects of power supply variations and hum are both considerably reduced by negative feedback.

In practice the choice of gain factor for the amplifier

must be a compromise; to reduce the effects of coupling time constants the gain should be large in order to allow a large amount of negative feedback to be applied, but in order to reduce the effects of stray couplings such as hum, etc., the gain should in fact not be too large. These considerations apply equally for any high-gain feedback amplifier and therefore, in general, the same precautions are applicable, such as hum bucking or, if necessary, use of d.c. heater supplies and screening of high-impedance bridge components.

D. E. D. HICKMAN.

## "Alternatives to the Wien Bridge"

I SHOULD like to comment on the article by J. F. Young which appeared in your issue of February 1959.

The article is of considerable interest but, unfortunately, the author did not review the case<sup>1</sup> when  $n > 1$ , and thus a condition contrary to that described in the article (Fig. 7). The increase of damping which takes place when  $n > 1$  is not of great importance, because it can be easily compensated by the amplifier. It is clear

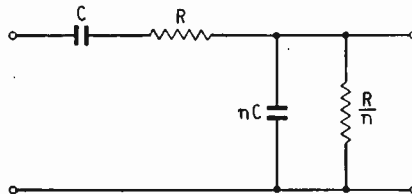

that the increase of selectivity can be attained for  $K=0$  (Fig. 10).

With great interest from a constant reader of your journal.

E. KUCHIS,

Institute of Physics & Mathematics,  
Academy of Sciences of L.S.S.R.

Vilna,

Lithuanian S.S.R.

<sup>1</sup> T. Zagalewski. Optimum Parameters for RC Generator in Wien Bridge, *Archiwum Electrotechniczne* (Polish), 1958, Vol. 7, No. 2, pages 273-288.

## Crystal Oscillator Pulling

THE division of crystal oscillator circuits on page 534 of the December 1959 issue contains errors which may mislead some readers. In particular S/Ldr. de Visme states that the amount by which the frequency may be pulled is  $f/Q$ , and thus implies that it depends on  $Q$ . The circuit he shows, however, is the Pierce (1923) circuit, the pulling conditions for which were described in *Wireless Engineer* (June 1941). In this paper it is shown that the pulling range is limited by the ratio of capacitances in the conventional representation of the crystal, a ratio which is always degraded by external circuit capacitances. Certainly ranges of a good deal more than  $f/Q$  can be obtained, for the limit of the ratio of capacitances is below 200, rather than over 20,000.

The alternative circuit with the crystal connected between anode and grid is analysed in a similar manner to that of the reference above by J. Coulon in a Toulouse University doctorate thesis, March 1948 ( $C_1$  is incorrectly labelled in Fig. 1).

London, W.8.

H. JEFFERSON.

### The author comments:

I am much indebted to Mr. Jefferson for pointing out my error in saying that the greatest degree of mistuning possible is of the order of  $f/Q$ .

The error arose from confusion in my mind between the response of a tuned circuit to a forcing frequency other than its resonant frequency—"pulling"—which naturally depends on the circuit Q, and the very different case of directly altering the reactive parameters of a self-oscillating circuit, thereby tuning it.

Taking the minimum possible crystal shunting capacity as about 180 times its equivalent series capacity, the frequency of oscillation of a loss-free crystal can be tuned through a range of  $f/360$ , corresponding to a change in shunt capacity from its minimum value to infinity. For  $f$  equal to 1 Mc/s, this comes to 2.8 kc/s. In fact, I was able to tune the crystal used in the calibrator through about 500 c/s; the difference between the two figures must be attributed mainly to additional capacitive shunting imposed by the associated circuit.

G. DE VISME.

## Inexpensive Photographic Timer

I NOTED with interest the ingenious circuit offered by your correspondent K. Hardisty in the December 1959 issue, whereby clean operation of the relay is obtained.

By the addition of a voltage stabilizer valve (85A2) to the original circuit (August 1958 issue) as shown in the sketch, a similar result is achieved, and calibration of the timing ranges is scarcely affected. As a result of this modification, most types of relay become suit-

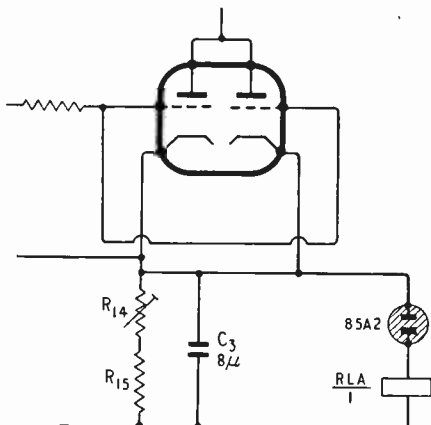

able, including some which previously had a tendency to chatter. Further, the timing period becomes more precise.

Among relays successfully tested in this system are:

- (a) The original Siemens h.s. relay with a 1,700 + 1,700Ω coil;
- (b) a P.O. type—600 relay with 5,000Ω coil;
- (c) a P.O. type—3,000 relay with 6,000Ω coil.

Lower resistance coils for the above relays may be suitable, but were not available for test.

Harrow. J. H. JOWETT.

[Mr. Hardisty has asked us to point out that the relay contact RLA/2 in his diagram should have been shown as normally closed. The sequence of operations is: 1—push-button operated, 2—capacitor discharges, 3—neon-lamp extinguishes and relay releases, 4—RLA/2 opens and capacitor begins to re-charge, 5—push-button released. As in Mr. Jowett's design, the enlarger lamp is off (RLA/2 open) when the relay is energized.—Ed.]

## "Servicemen's Pay"

ON page 540 of your issue for December, 1959, you publish details of an agreement between the R.T.R.A. and a body called the Association of Radio and Electronic Engineers.

No intelligent television service engineer will be impressed by the published terms of this so-called agreement. First, because the rate of pay for a man who has served a five-year apprenticeship is under rate by £1 15s 2d in the provinces and £1 6s in the London

area compared with E.T.U. agreements in England and Scotland\*.

Secondly, by its emphasis on the possession by radio and television engineers of the R.T.E.B. certificate, the agreement fails to face up to the fact that the overwhelming majority of skilled television servicing is carried out by highly skilled but, nevertheless, uncertificated engineers†.

This is due to the rapid growth of television and the continued refusal on the part of the Radio and Television Retailers' Association, and the industry, to face up to the need for proper industrial relations and an adequate apprenticeship and training scheme.

Striking evidence of the refusal on the part of the R.T.R.A. to face realities and negotiate with the Electrical Trades Union was to be seen at this year's Radio Exhibition where the R.T.R.A. stand displayed literature advertising a Joint Apprenticeship Council for the industry and proclaiming that the employees were represented on that body by the Guild of Radio Service Engineers, a body (according to the report of the Registrar of Friendly Societies) that has not got a single member and that has ceased to function as a trade union for more than five years.

This Association of Radio and Electronic Engineers represents the latest effort on the part of the R.T.R.A. to offset the growing television membership of the Electrical Trades Union, and consequently its justifiable claims for recognition as the appropriate body to represent the interests of television engineers.

Television service engineers will be all the more reluctant to place much confidence in the claims of the A.R.E.E. to represent them when they learn from the Registrar of Friendly Societies that its contribution income for 1957 was £29 for a total membership of 32. In 1958, however, they claimed a membership of 285, but, strangely enough, they only produced an income of £28 11s 6d.

Other useful information available in the Registrar's report disclosed the fact that neither in 1957 nor in 1958 did this organization engage in any expenditure on benefits, wages, rent or working expenses, in spite of the fact that it has a General Secretary and a registered office at 17, Tottenham Court Road, London, W.1 (just round the corner from the R.T.R.A.'s office).

A. C. BATCHELOR,

National Officer, Electrical Trades Union.  
Hayes, Bromley, Kent.

\* It is learned on enquiry from the Electrical Trades Union that the R.T.R.A./A.R.E.E. rate is here compared with the national minimum rate [£13 2s 6d] established under the E.T.U. agreement with the Electrical Contractors' Association of Scotland. Reference was made in the Report to the Union's 1959 Policy Conference to the need for "the laying down of a minimum rate of pay for radio and television service engineers."

† The R.T.R.A./A.R.E.E. rate for a certificated television service technician is above the minimum basic E.T.U. rate by 5s 2d in the provinces and 16s 2d in London.—Ed.

## Editors and Editing

I WAS interested to see your comments in the January issue on my letter on editors and editing. You will see that I have taken to heart your comment No. 4 about capital letters for common nouns and have addressed this letter to the editor of "wireless world," although I regret to notice that in your comment No. 10 you have yourself suffered a lapse. Comment No. 8 has enlightened me on many points—I had not previously realized that sub-editing is carried out by dull mechanics.

Comment No. 5 illustrates very well the sort of thing I am often up against. I don't use words that I don't know the meaning of, but I often find that editors think they know what I mean better than I do myself.

Finally, your suggestion in comment No. 6 makes me shudder. The style is the scientific equivalent of the officialese that Government Departments are continually bombarding us with, and although the sentence is finite I find it difficult to comprehend as a whole.

Chelmsford.

R. A. WALDRON.

# THE SMITH CHART

## 2.—Effects of Load, Input Impedance and Matching on Transmission Lines

By R. A. HICKSON\*

(Continued from page 9 in the January issue)

IT was explained in the first part of this article how the Smith chart is derived. We can now turn to a consideration of some of its principal applications in connection with transmission lines and aerial systems.

**Effect of Load on Transmission Line.**—(i) *Magnitude and Phase Angle of Reflection Coefficient at the Load.*—Given  $Z$ , locate it on the chart and draw a line from the centre through the point to the edge. The distance of the point from the centre, transferred to the reflection coefficient scale, gives the magnitude. The phase angle is read from the scale round the edge.

Given  $y$ , locate it on the chart and draw a line from the point through the centre to the edge of the chart. The distance of the point from the centre, transferred to the reflection coefficient scale, gives the magnitude. The phase angle is read from the scale round the edge.

*Example (a).*—A load of  $45 + j30$  ohms is connected to a 75-ohm line.

$$z = \frac{Z}{Z_0} = \frac{45 + j30}{75} = 0.6 + j0.4$$

(Point A Fig. 11). From this it can be seen that the reflection coefficient is  $0.34 (+121^\circ)$ .

*Example (b).*—A load of  $0.02 - j0.03$  mho is connected to a 50-ohm line:

$$y = \frac{Y}{Y_0} = \frac{0.02 - j0.03}{0.02} = 1 - j1.5$$

(Point B Fig. 11). It can be seen that the reflection coefficient is  $0.60 (+127^\circ)$ .

(ii) *Voltage Standing Wave Ratio.*—Given  $z$  or  $y$ , locate it on the chart and draw an arc of a circle centred on the centre of the chart moving clockwise from the point. The arc will cross the pure resistance axis at a normalized resistance equal to the v.s.w.r. at the load.

The v.s.w.r. at any point along the line may be obtained by moving towards the centre of the chart by an amount indicated by the "Effect of Line Attenuation" scale.

*Example.*—Load =  $0.6 + j0.4$  (normalized); v.s.w.r. at load = 2.05 (Fig. 12). To find the v.s.w.r. at the end of 150 feet of cable having a loss of 4dB/100 feet at the operating frequency. Line attenuation =  $150 \times 4/100 = 6$ dB. Moving from 2.05 on the v.s.w.r. scale on to the "Effect of Line Attenuation" scale, 6dB towards the generator on this scale and then back to the v.s.w.r. scale, we find: v.s.w.r. at end of line = 1.18.

**Input Impedance of a Transmission Line.**—(i) *Mismatched Line.*—Given  $z$  and  $l$ , locate  $z$  on the chart and draw an arc of a circle centred on the centre of the chart moving clockwise from the point. The length of the arc, measured on the

wavelengths scale, should be  $l$ ; if  $l$  is greater than a half-wavelength, an integral number of half-wavelengths should be subtracted from it. The normalized input impedance is indicated at the end of the arc (Point A, Fig. 13).

The effect of line attenuation may be obtained by moving toward the centre of the chart by an amount indicated by the "Effect of Line Attenuation" scale. (Transmission Loss)

*Example.*—

Normalized load =  $0.6 + j0.4$ .

Length of line = 30 metres.

Velocity factor = 0.833.

Operating frequency = 209.75 Mc/s.

$$l = \frac{209.75 \times 30}{300 \times 0.833} = 25.17 \text{ wavelengths.}$$

Moving clockwise 0.17 wavelength from  $0.6 + j0.4$  brings us to  $2.05 - j0.03$  (Point A). The radial distance of this point from the centre of the chart is transferred to the "Effect of Line Attenuation" scale (Point A'). Assuming that the line loss is 6dB we move six 1-dB steps along this scale to point B'. The radial distance of this point from the centre of the circle, along the line from the centre to point A, gives us point B, the input impedance allowing for line losses. This is 1.2, and has a slight capacitive component ( $j = -0.01$ ) but the chart cannot be read to such a degree of accuracy.

(ii) *Length of Line Required to Produce a Required Reactance.*—A short-circuited line will have a reactance of zero at the short circuit. The reactance at the input of a short-circuited line may be found by moving round the outside of the chart from the zero point by a distance on the "Wavelengths Towards Generator" scale corresponding to the length of a stub.

Similarly with an open-circuited line, we start at the infinity point and move round the outside of the chart in the same direction.

If the shortest possible line is required, an open-circuited line will be chosen when a capacitive reactance is required and a short-circuited line for an inductive reactance.

The effect of line losses is generally negligible for such short sections of line, producing a resistive component in the input impedance of at most 0.01. More important is the fact that the open or short circuit is not always ideal and may itself contain a resistive component. Fringing effect in open circuits is a cause of this. With balanced lines, a short circuit must extend over an area of dimensions comparable with a wavelength to be effective, and for measurements the most reliable termination is a short circuit on a coaxial line.

(iii) *Line Characteristics.*—The procedures described in (i) and (ii) require a knowledge of the characteristic impedance, attenuation and velocity factor of the

\* Belling and Lee Ltd



line. By a converse process we can deduce the characteristics of the line from measurements of the input impedance of a known length of line at six or eight known frequencies: ideally two frequencies would suffice, but, as always, redundancy improves reliability.

**Characteristic Impedance.**—The normal method for this is to take the geometric mean of the input impedances with the far end of the line first short circuited and then open circuited. These impedances are sometimes made resistive by cutting the line to resonance and/or varying the frequency of measure-

ment. The effect of measurements at resonance is reproduced by means of the Smith Chart, using an arbitrary length of line and a set of arbitrary frequencies. The use of different frequencies allows the input impedance of the line at various electrical lengths to be measured. The frequency band over which measurements are made should be such as to give a change in electrical length of one half-wavelength. A larger band than necessary will introduce changes in attenuation per unit length which must be allowed for in plotting the results (on the basis, attenuation (dB) =  $k\sqrt{\text{frequency}}$ ). The input impedances relative to the measuring system will lie on a circle which crosses the pure resistance axis at points representing a line length of (a) an exact number of half-wavelengths (each repeating the load) and (b) an exact odd number of quarter-wavelengths (each inverting the load). The line impedance relative to the measuring system is the geometric mean of these two resistance values.

**Velocity Factor.**—The measured impedances may now be replotted relative to the line impedance, making a new circle centred on the centre of the chart.

The velocity factor is given by:—

$$v.f. = \frac{\delta F \times L}{\delta l \times 300}$$

where  $\delta F$  in Mc/s is the change in frequency required to produce a change  $\delta l$  in the length of the line in wavelengths, and  $L$  is the physical length of the line in metres. The wavelength change  $\delta l$  is determined from the replotted points with the aid of the "Wavelengths" scale.

**Attenuation.**—The attenuation in decibels of the length of line used is given by the radial distance of the replotted points from the edge of the chart, measured on the "Effect of Line Attenuation" scale.

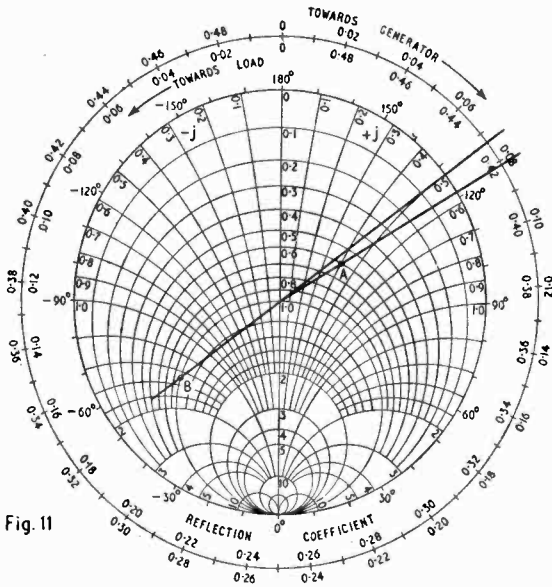

Fig. 11

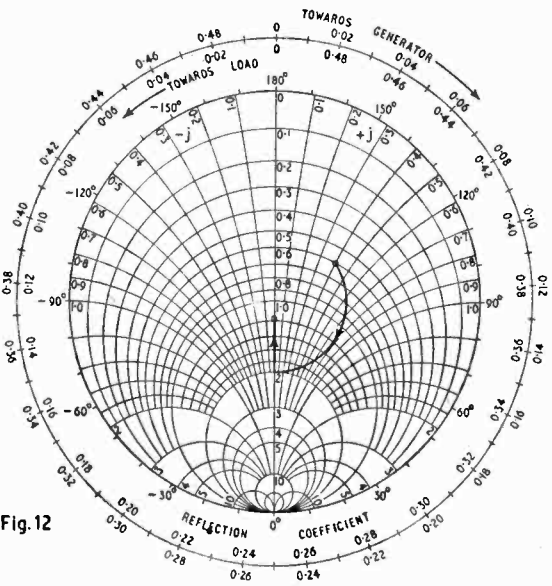

Fig. 12

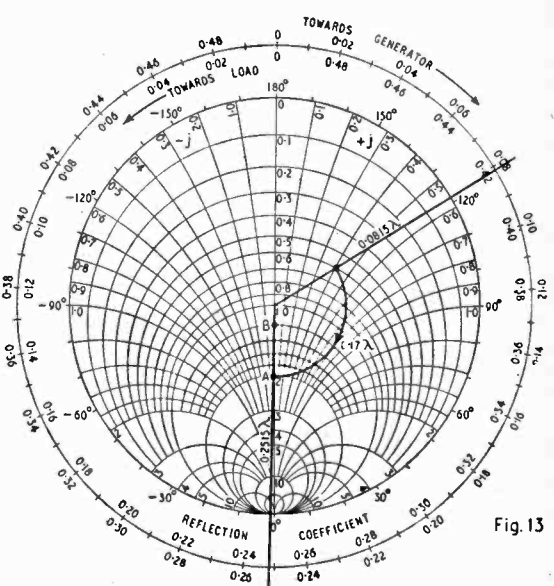
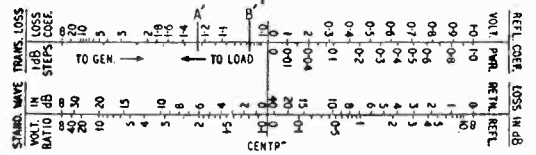

Fig. 13

Fig. 11. Reflection coefficient of an impedance (A) and an admittance (B).

Fig. 12. V.S.W.R. at the generator end of a line.

Fig. 13. Input impedance of a mismatched line: neglecting losses, A; allowing for losses, B.



As an example of the use of the foregoing method we will refer to Fig. 14. Points marked with a cross are the input impedances, relative to 50 ohms of a 14-metre length of short-circuited line. Figures adjacent to each point indicate the frequency in Mc/s. The circle through these points crosses the pure resistance axis at 0.05 and 5.0. The characteristic impedance of the line is therefore:—

$$Z_0 = \sqrt{0.05 \times 5.0 \times 50} = 25 \text{ ohms.}$$

The velocity factor is:—

$$\frac{(95 - 88) \times 14}{0.49 \times 300} = 0.67$$

The attenuation is:—

$$0.85\text{dB per 14 metres} \\ \text{or } 1.85\text{dB per 100 feet.}$$

For the most accurate results the loss of the length of cable used should be between 2.5dB and 10dB.

**Nature of an Unknown Load.**—Using a slotted line, the v.s.w.r. produced by the load may be measured directly, as may the change in position of the standing wave pattern produced by replacing the unknown load with a short circuit. Normally the change in position of a voltage minimum is

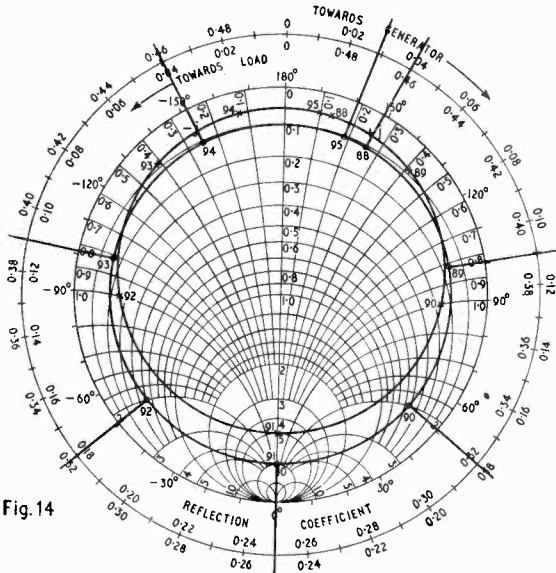

Fig. 14

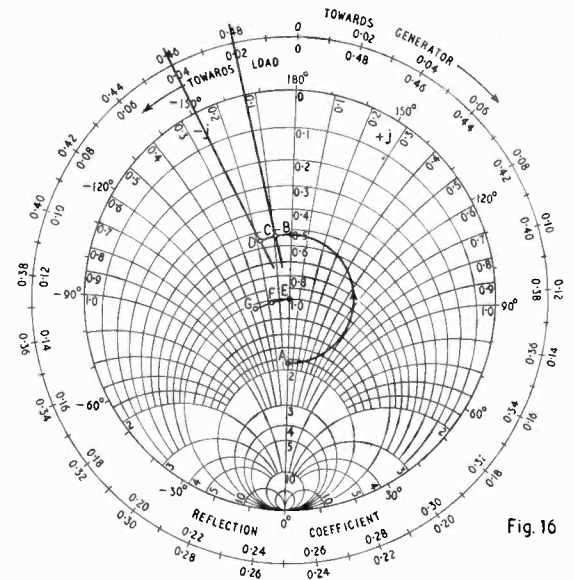

Fig. 16

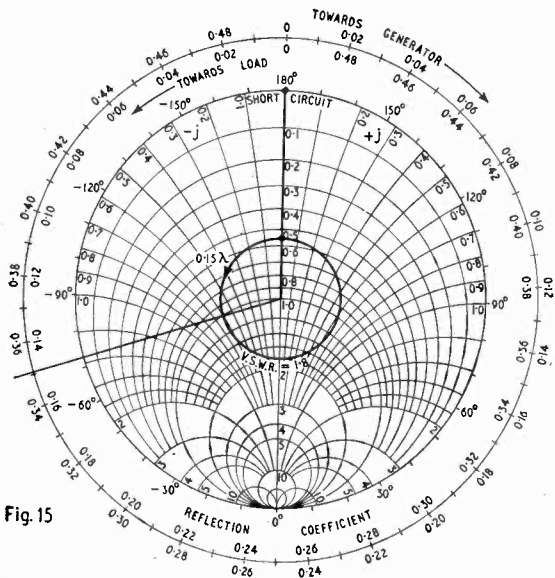

Fig. 15

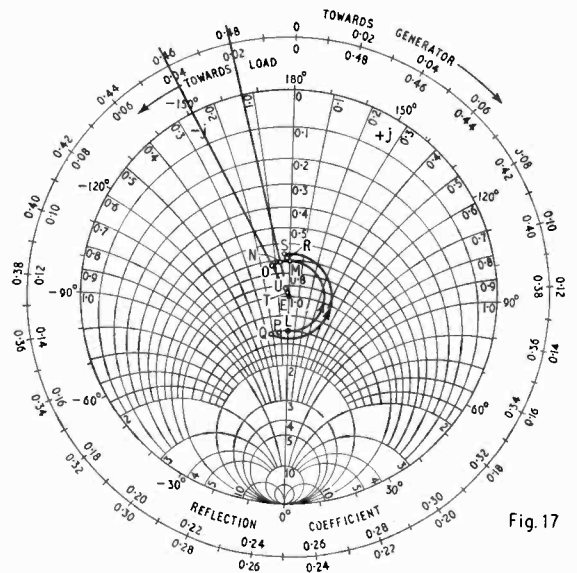

Fig. 17

Fig. 14. Input impedance of a short-circuited line at various frequencies: X = relative to test gear; O = relative to  $Z_0$

Fig. 15. Slotted-line method for determining load impedance.

Fig. 16. Matching with single quarter-wavelength section.

Fig. 17. Matching with two quarter-wavelength sections, over the same frequency range as in Fig. 16.

chosen, as the minima are sharper than the maxima. The procedure is as follows:—

Measure the v.s.w.r. with the load in place and note the position of a convenient voltage minimum. Replace the load by a short circuit and note the position of new voltage minima, selecting the minimum which is not more than a quarter-wavelength from the first minimum. The wavelength in the slotted line is determined by measuring the distance between adjacent minima, which corresponds to one half-wavelength.

The load lies on the circle corresponding to the v.s.w.r., so this circle is drawn in, using the pure resistance scale or the separate v.s.w.r. scale. Starting at the point where this circle cuts the pure resistance axis at a value less than 1, move along the circle a distance corresponding to the distance moved by the voltage minimum, in the direction (towards the generator or the load) in which the minimum moved when the load was replaced by a short circuit. The point reached represents the load impedance. *Example.*—The indicated v.s.w.r. is 1.8, the distance between adjacent voltage minima is 20cm and the replacement of the load by a short circuit shifts the minima 6cm toward the generator. The shift in terms of wavelengths is  $6/20 \times 2 = 0.15$  wavelength (Fig. 15).

Moving this distance toward the generator along the "v.s.w.r. = 1.8 circle" brings us to a load impedance of  $1.0 - j0.6$ . If a 50-ohm slotted line is used the impedance is  $50 - j30$  ohms.

**Matching Two Resistive Impedances.**—As shown in the section "Impedance Variations along a Mismatched Line" in Part 1, a quarter-wavelength section of line will match two resistive impedances  $z_1$  and  $z_2$  such that  $1/z_1 = z_2$ . For example, to match a 300-ohm line to an 80-ohm line, a quarter-wavelength section would be required of such an impedance that  $Z_0/80 = 300/Z_0$ , i.e.,  $Z_0 = 155$  ohms.

This matching will of course only be correct at the one frequency for which the length of the matching section is exactly a quarter-wavelength.

Referring to Fig. 16, Point A represents 300 ohms with respect to 155 ohms. This point is transformed to B at the correct frequency, to C at the frequency for which the line is 0.27 wavelength long and to D at the frequency for which the line is 0.29 wavelength long. These points, when normalized with respect to 80 ohms, become points E, F and G.

The matching may be improved by using two quarter-wavelength sections to change the impedance in two stages. In this case, matching 300 to 155 ohms with a 216-ohm section, and matching 155 to 80 ohms with a 111-ohm section. Referring to Fig. 17, Point L represents 300 ohms with respect to 216 ohms. This point is transformed to M at the correct frequency, to N at the frequency for which the line is 0.27 wavelength long and to O at the frequency for which the line is 0.29 wavelength long. These points represent the output impedance of the first section normalized with respect to 216 ohms. To represent the input impedance of the second section they must be renormalized with respect to 111 ohms, when they become points L (again), P and Q respectively. These points are transformed to M (again), R and S, by the 111-ohm section. When normalized with respect to 80 ohms they become points E (again), T and U.

The improvement obtained by use of two sections is apparent: the v.s.w.r. represented by point U is less than 1.1, compared with 1.4 for point G. The use of more sections will give a further improvement, leading in the long run to an infinity long line, the impedance of which changes exponentially. Short tapered sections of line have been used in which the length and character of the taper are usually determined experimentally. Exponential, linear and Gaussian tapers have been used. A recent paper (Ref. 6) contains details of the design of a practical exponential-line transformer.

#### REFERENCES

- <sup>6</sup> S. G. Young. "H.F. Exponential-Line Transformers." *Electronic & Radio Engineer*, February 1959, Volume 36, No. 2, pp. 40-44.

## SHORT-WAVE CONDITIONS

Prediction for February

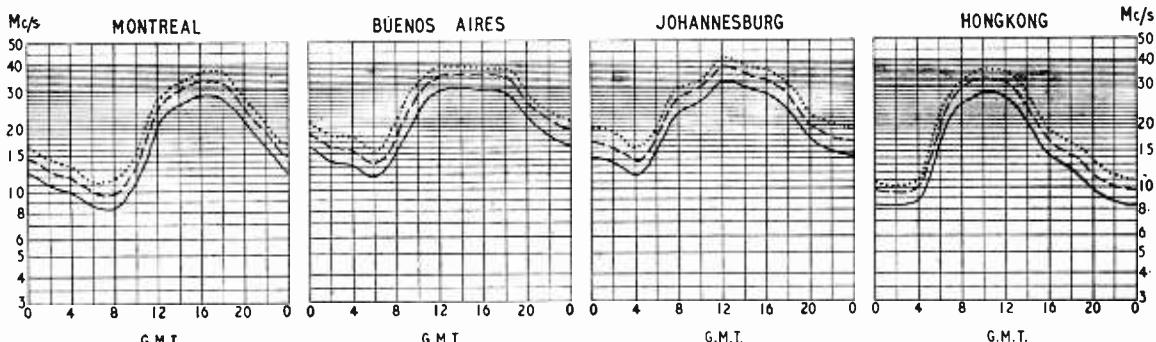

THE full-line curves indicate the highest frequencies likely to be usable at any time of the day or night for reliable communications over four long-distance paths from this country during February.

Broken-line curves give the highest frequencies that will sustain a partial service throughout the same period.

- ..... FREQUENCY BELOW WHICH COMMUNICATION SHOULD BE POSSIBLE FOR 25% OF THE TOTAL TIME
- - - - - PREDICTED MEDIAN STANDARD MAXIMUM USABLE FREQUENCY
- FREQUENCY BELOW WHICH COMMUNICATION SHOULD BE POSSIBLE ON ALL UNDISTURBED DAYS

# Tunnel Diode

NEW SUPER-HIGH-FREQUENCY SEMICONDUCTOR DEVICE

A NEGATIVE resistance characteristic which can be made use of at super-high frequencies ( $>3,000\text{Mc/s}$ ) is the main feature of tunnel diodes. These diodes consist of heavily-doped (impurity content as high as  $\approx 10^{20}$  atoms/c.c.) p- and n-type regions connected by a very thin ( $\approx 10^{-6}\text{cm}$  wide) depletion layer sometimes called a space-charge region. When a voltage is applied to such diodes from the p- to the n-region (forward bias) the current at first increases with increasing voltage and then, at a potential of a few hundred millivolts, decreases again before finally increasing as in an ordinary conducting diode (see diagram). The region of decreasing

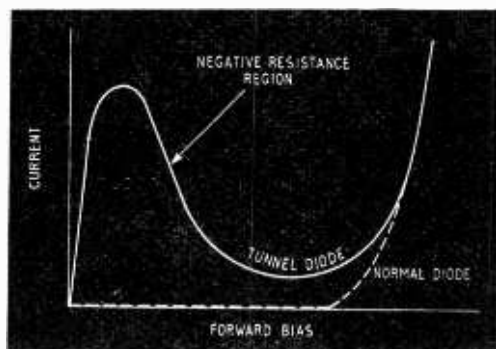

General voltage/current characteristics of tunnel and normal diodes for forward bias voltages (adapted from Fig. 1 of the article by H. S. Sommers et al. in Part 3 of the 1959 I.R.E. Wescon Convention Record (p.3)).

current corresponds to a negative dynamic resistance. This negative resistance in tunnel diodes was first reported by L. Esaki in *Physical Review*, Vol. 109, p. 603 (1958).

At low voltages, before the normal conduction current level in these diodes is reached, the current is provided by the majority carriers going through a quantum-mechanical process known as tunnelling—hence the name given to these diodes. Using the picture of atomic particles as waves of probability, tunnelling may be looked upon as being due to the fact that the waves of a charged particle can penetrate partially a potential barrier even when the particle does not have enough energy to surmount the barrier. Now a wave on the other side of the barrier represents a finite probability of finding the particle on the other side of the barrier. If and when this probability is realized, and the particle appears on the other side of the barrier even though it did not have sufficient energy to surmount the barrier, the particle is said to have tunneled through the barrier. Of course, the particle can only tunnel through the barrier if it can fill a vacant energy level on the other side. In the tunnel diode certain energy levels cannot be filled and are said to be forbidden. It is the effect of the applied voltage on these forbidden levels which produces the low-voltage/current characteristic of the tunnel diode. For example, at certain small forward applied voltages, the forbidden levels in the p-region overlap the electron energy levels in the n-region. Thus the electron flow from the n- to p-region is decreased and a negative resistance characteristic produced. To complicate the picture still further, in certain directions

relative to the semiconductor crystal lattice structure phonons (ultrasonic vibrations of the crystal lattice) can interact with the electrons so as to assist the electron tunnelling process.

One advantage of tunnel diodes is that they can operate at super-high frequencies ( $>3,000\text{Mc/s}$ ). Since these diodes are majority rather than minority carrier devices, the maximum operating frequency of minority carrier devices (such as the transistor) set by the minority carrier transit time does not apply to tunnel diodes. In the case of tunnel diodes, the maximum operating frequency increases with increasing doping (impurity concentration). Since as the doping increases the impedance decreases, the maximum practical operating frequency of the tunnel diode may be set either by the minimum usable circuit impedance, or by the maximum achievable doping. Such practical considerations are likely to limit operation to below  $10,000\text{Mc/s}$  in the case of germanium tunnel diodes, but higher frequencies should be achievable by using other semiconductors such as germanium arsenide as the tunnel diode material. Germanium tunnel diodes have in fact already been made which can oscillate at  $4,000\text{Mc/s}$ . Such oscillations can be obtained by biasing the diode to a point on the negative resistance portion of its characteristic and placing it across a resonant circuit. The capacitance in the resonant circuit can be obtained from the tunnel diode junction capacitance, and the inductance, at these high frequencies, from a short length of conducting material. Alternatively, the diode can be placed at a suitable position across a short-circuited transmission line.

Since the tunnel diode characteristic consists of a negative resistance region separating two positive resistance regions, such diodes can also be used as very fast switches, and switching times of less than  $1\text{m}\mu\text{sec}$  have already been achieved. Besides their very high maximum operating frequency, another advantage of tunnel diodes is their wide possible range of operating temperature. Tunnel diodes can in fact operate from about  $4^\circ$  absolute up to about  $200^\circ\text{C}$  in the case of germanium, or up to about  $400^\circ\text{C}$  in the case of silicon diodes. One disadvantage of tunnel diodes inherent in all two-terminal devices is the difficulty of separating input and output circuits. Various aspects of the tunnel diode are described in *Proc. I.R.E.* for July 1959 (p. 1201) by H. S. Sommers, and in papers by H. S. Sommers et al. and I. A. Lesk et al. in Part 3 of the 1959 I.R.E. Wescon Convention Record.

## Automatic D.F. Aids Radar Identification

NOW in operation at De Havilland's Hatfield aerodrome are a Marconi Type S232 50-kW 50-cm radar and Automatic Fixer. This latter uses two Type AD200 v.h.f. direction finders, one at Hatfield, the other near Chelmsford (controlled by a v.h.f.-radio link).

The outputs of the two direction finders are fed into the Automatic Fixer which uses a 17-in c.r.t. display covered by a transparent map of the area. When an aircraft calls Hatfield on v.h.f. two traces, which originate from the positions of the d.f. stations and indicate the aircraft's bearing, are produced. These traces intersect at the aircraft position, so enabling the radar-display point to be identified without recourse to an aircraft manoeuvre.

**Handwriting Recognizer**, capable of identifying any one of ten words, "zero," "one," "two" . . . etc., to "nine," written in cursive script, has been devised at Bell Telephone Laboratories. To use the device the words have to be "written" with a metal stylus on an electrode system. Then, when an "Identify" button is touched with the stylus, a light appears beside the numeral corresponding to the word just written. The device examines words as a whole, not by their individual letters. It picks out features of the overall shapes of the words, including the length of word, the dotting of "i's" and the number and position of vertically extended letters such as "h" and "g." The electrode system consists of 15 horizontal metal strips alternately sandwiched between strips of electrical insulating material. Up-an-down movements of the writing stylus gives a sequence of electrical connections with the metal strips. The sequence and number of connections are an indication of which of the ten words has been written. To provide the writer with horizontal guide lines, two of the 15 horizontal bars on the writing surface are made of brass, making a colour contrast with the others, which are copper. The two brass conductors enclose the middle one-third of the writing space, in which the user writes small letters, such as "e" and "n." Vertically extended letters, such as "t" and "g," are carried beyond these limits. The middle bar of the surface is connected to a counter, which gives a rough horizontal location of features. If a recognition feature comes before the

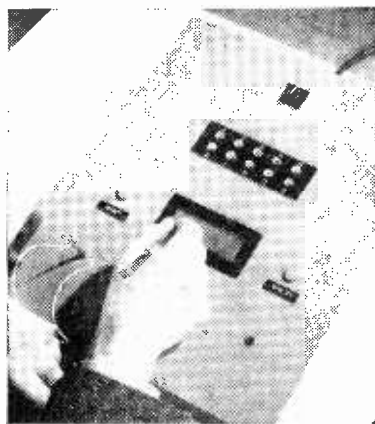

stylus has crossed this middle bar six times the feature is considered to be in the left-hand portion of the word; if later, it is considered to be in the centre or right portion. A logic circuit, consisting of 12 relays and eight diodes, examines each word for six features. These are: a lower vertical extension, as in "g," within the left-hand portion of the word; a

# Technical Notebook

lower extension in the middle or right-hand portion; an upper extension, as in "t," in the left-hand portion; the presence of more than one upper-left extension; a large number (more than nine) crossings of the middle bar; and a dotted "i." As examples, "zero" is identified by a lower-left extension; "four" by both upper- and lower-left extensions; "seven" by more than nine crossings of the middle bar. Theoretically, four separate tests for features are sufficient to identify ten words. This system, however, applies two extra or redundant tests to allow for the great variation in writing styles. The accuracy of the recognizer is said to be 97% of words correctly identified in a test of 1,000 words written by 20 people.

**Interstellar Communications** in the form of radio transmissions from any civilizations that may exist on planets revolving around neighbouring stars may be receivable according to G. Cocconi and P. Morrison in *Nature* for Sept. 19, 1959 (p. 844). Frequencies below about 1Mc/s and above about  $3 \times 10^4$ Mc/s are unlikely to be used for such transmissions either because they are absorbed too greatly in planetary atmospheres or, where this absorption is not serious (at frequencies in or near the visible region), because the power required to produce a receivable signal is impractically large. In the remaining useful frequency band from about 1Mc/s to  $3 \times 10^4$ Mc/s interfering radiation is produced by the galaxy as a whole and also by the neighbouring star (since any feasible size of radio telescope will have a resolving power which will almost certainly be too small to separate a source on a planet from its neighbouring star). These two sources of interfering radiation in the useful frequency band produce a total received power which varies with frequency and is a minimum at frequencies of the order of  $10^4$ Mc/s. Frequencies which would be easy to find are provided by molecular or atomic resonances since these occur at the same frequencies throughout the universe. Such a frequency is provided in the region of minimum interfering radiation by the hydrogen line at 1,420Mc/s. The authors thus suggest a search around this frequency

for such transmissions. The transmitter power and aerial size required for producing a signal stronger than the interfering radiation at this frequency are not much beyond even the present technical capabilities of this earth, and are within what is already planned. The authors suggest that the most likely form of modulation for such a signal would be pulse modulation. The modulation period is unlikely to be very much greater or much less than a second owing to bandwidth and planetary rotation period restrictions. An easily identifiable message would be provided by modulations forming a standard numerical series such as the first few prime numbers. From our present knowledge it is thus quite practicable to receive signals from any civilizations that may exist on planets of neighbouring stars. The authors feel that the importance which the reception of such signals would have overrides the probability that a search for them would prove fruitless.

**F.M. Receiver Distortion** in the i.f. stages and discriminator can be reduced by decreasing the maximum i.f. signal frequency deviation. This can be done by changing the local oscillator frequency in phase with the changes in the transmitted signal frequency produced by the audio modulation. The required changes in the local oscillator frequency can be obtained by using the audio output from the discriminator as a frequency control signal. Circuit details of how this is done in the American Allied Radio Knight tuner are given in *Electronic Equipment Engineering* for July 1959 (p. 25). This system decreases the distortion in proportion to the reduction in the i.f. deviation at normal deviations and by a much greater amount should the unreduced i.f. deviation exceed the i.f. and/or discriminator bandwidths. Two other advantages of reducing the i.f. deviation are that, since the bandwidths of the i.f. and discriminator stages can be decreased, the gain of these stages can be increased, and they can be more easily constructed. The signal-to-noise ratio is not changed by reducing the i.f. deviation, since most of the noise is produced in the r.f. stage.

# Transistor Constant-Volume Amplifier

Gain Control by Input Resistance Variation

By G. J. POPE

**V**OLUME compressors or constant-volume amplifiers are commonly used in communications systems to equalize volume variations experienced when different operators are liable to broadcast announcements. Further, positioning of microphones becomes less critical and larger average modulation depths may be employed so that an improvement in the signal-to-noise ratio of the system is achieved.

The principle of such circuits involves the inclusion of some variable-gain element in the forward a.f. path, with provision for the automatic adjustment of the gain in inverse proportion to the strength of the incoming signal. By this arrangement, the output approaches a constant level irrespective of the average input level. In order to avoid overmodulation and excessive distortion, the device must be fast to respond to initial syllables of speech after a pause when the gain will have risen to a high level. The rate of recovery of the no-signal high-gain condition during pauses in speech must not be so fast that a disconcerting "snatching" effect occurs at every ensuing opening syllable.

Understandably, the rate of operation of the amplifier must take a finite time, since energy must be obtained from the incoming signal (suitably amplified of course) to charge a capacitor, the level of which charge decides the setting of the variable-gain device. An operating time of 100 msec for a maximum level input signal from silence has been found to be satisfactory in practice. The capacitor is arranged to discharge to any required lower level during pauses in speech over the space of 3-5 seconds, this period having been found to be satisfactory from an intelligibility and listening comfort point of view.

The constant-volume amplifier to be described has been designed to provide substantially similar output signal levels for various operator speech input levels. It is suitable for operation directly from a moving-coil microphone or via a pre-amplifier from a ribbon microphone.

The amplifier consists of four main sections (see Fig. 1):—

- (1) Gain-controlled stages VT1 and VT2.
- (2) Bias amplifier VT4, 5 and 6.
- (3) Bias detector and buffer stages MR1 and VT3.
- (4) A.F. amplifier VT7 and VT8.

**Gain-controlled Stages.**—Stages VT1 and VT2 are controlled-gain amplifiers, the input resistances of which are controlled by the a.g.c. bias fed back via the grounded-collector stage VT3. The same control principles are used as those in a well-tried a.g.c. circuit used in transistor broadcast receivers. Here the dependence of the input resistance of a transistor on the d.c. emitter current is used to control the a.c. input current supplied from the signal source. The best control range will be obtained when the signal source is of low resistance.

The overall feedback loop phase change at mid-band frequencies has been arranged to be 180 degrees, as this obviously aids the basic stability of the circuit when using the most convenient design of bias amplifier. Unfortunately, this means that the bias is fed into the emitter circuits of the controlled stages, which loses the power gain opportunities which would be obtained if the base circuit were fed. However, the present amplifier buffer-stage combination has adequate gain to provide a reasonable compression characteristic.

In accordance with well-established technique in constant-volume amplifier design, push-pull working of the controlled amplifier is arranged. Recombination of the two outputs in a transformer results in cancellation (depending on the degree of balance of the two transistors) of the d.c. "thump" transient that occurs in the collector circuit due to the sudden change of bias and thus collector current on the receipt of a signal level increase. This result is due to the application of the bias to the two emitter circuits in parallel whilst the a.f. is applied to the emitter circuits in a normal push-pull circuit fashion.

The noise level contributed by the controlled

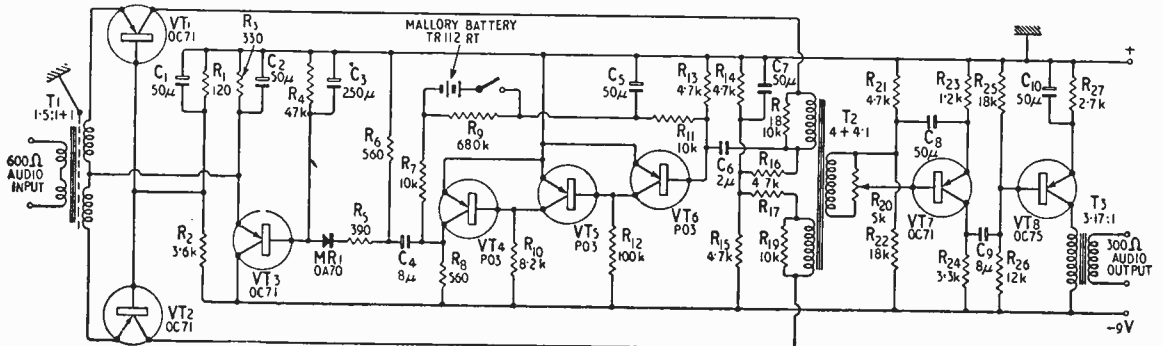

Fig. 1. Circuit diagram of constant-volume amplifier.

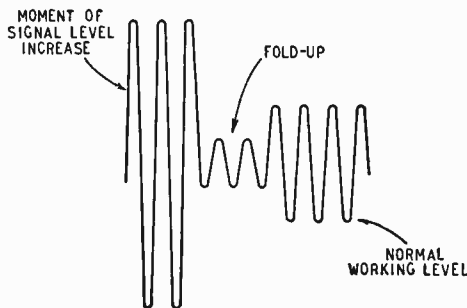

Fig. 2. Fold-up effect in output signal.

stage may be kept to a minimum by operating the collectors from a low d.c. voltage. However, due to the presence of the bias stage feed resistor  $R_{16}$  and the necessity for providing sufficient minimum operating voltage to the stage under maximum-current conditions, the collector supply voltage must not be lowered too far. Approximately 4.5V has been fixed upon as the best compromise. This potential is provided by the divider network  $R_{14}$  and  $R_{15}$  across the supply.

The no-signal standing biases in VT1 and VT2 are chosen so that the two stages are on the threshold of their maximum-gain condition. Any reduction in this bias value will also increase the effective input resistance and decrease the stage gain.

**Bias Amplifier.**—In order to avoid the phase change which would result at each end of the audio spectrum if the bias amplifier were fed from the secondary of T2, a resistor  $R_{16}$  is included in the collector circuit of VT1 and the bias amplifier fed from this. This procedure reduces phase changes between the bias amplifier and the forward a.f. loop to a minimum when the controlled transistors are operated in the grounded-base mode, since they will then be effectively constant-current generators.

Despite the fact that the feedback circuit to the gain-controlled stages VT1 and VT2 acts nominally only at d.c., it is good practice to ensure that the phase change around the bias feedback loop is a nominal 180 degrees at mid-band frequencies. Reactive elements must be chosen to avoid instability due to additional phase changes at the upper and lower extremities of the audio band.

For a good compression characteristic, a large gain around the feedback loop is required. In order to avoid as far as possible the extra phase change due to capacitive coupling which could be troublesome at low frequencies, d.c. coupling techniques have been used in the bias amplifier. The circuit design is based on material in articles by G. B. Chaplin and A. R. Owens (*Proc. I.E.E., Part B*, May 1958, p. 258) and by D. A. G. Tait (*Wireless World*, May 1958, p. 237), use being made of the fact that the  $\alpha'$  of grounded-emitter stages is maintained down to a very low value of collector voltage so that direct connection between collector and next stage base circuits may be made. The first stage of the bias amplifier VT6 has its base circuit returned to earth via a 4.7k $\Omega$  resistor to keep  $I_{e0}$  reasonably low, and obtains its bias from the collector of VT4, this connection providing negative feedback. This occurs only at d.c. since a.c. components are filtered out by capacitor  $C_5$ . The 2.6V Mallory battery in the bias lead effectively

stabilizes the collector voltage of VT4 at a little above this figure, since any tendency of the bias applied to VT6 from the feedback chain to feed through the amplifier and increase the current in VT4 is removed if the collector voltage of VT4 falls below the potential on the bias line at this point. (Mallory battery potential +VT6 base potential = VT4 collector potential.) This value of collector voltage for VT4 ensures a sufficient a.c. swing without distortion in the presence of maximum signal input. The resistor  $R_9$  across the Mallory battery provides a small discharge current to cancel the charge component which flows round the bias circuit during normal operation (5 $\mu$ A approximately).

**Bias Rectification Circuit MR1 and Buffer Stage VT3.**—As mentioned earlier, fast-to-operate and slow-to-restore features are necessary for the overall amplifier characteristic if distortion and loss of intelligibility are to be avoided. A series diode rectifier will charge its reservoir capacitor in a short time and discharge it at a rate dependent on the time constant of the load circuit, provided that the rectifier has a low forward and a high backward resistance. The circuit configuration of the bias amplifier necessitates  $R_6$  as a "return" resistor for the diode circuit. The value of this resistor is a compromise decided on the one hand by the need to avoid undue shunting of the amplifier load  $R_5$  and on the other by the fact that it must not unduly increase the charge time of reservoir capacitor  $C_3$ .

In practice, the charge time of  $C_3$  must be degraded to a small extent however by the addition of a resistor  $R_8$  in series with the bias rectifier. This has been found necessary to remove a fold-up effect (see Fig. 2) in the operating characteristic which is probably due to the "thump" voltage which is fed through the bias amplifier from the collector circuit of VT1, there being no thump cancellation in the bias path.

At first it might be considered that similar results could be obtained if  $R_5$  were omitted and  $R_6$  merely increased in value, but this was not found to be the case in practice. The present value of 390 $\Omega$  for  $R_5$  was found to be the best compromise value for use with the 250 $\mu$ F reservoir capacitor  $C_3$ , although some adjustment may be necessary in other models. The emitter circuits of VT1 and VT2 are of low impedance and it is necessary to apply the control bias to them via an impedance transformation stage VT3. This presents a fairly high impedance to the bias rectifier circuit which enables a practically realizable value to be used for the reservoir capacitor. Capacitors  $C_1$  and  $C_2$  by-pass the biasing circuits to VT1 and VT2 at a.f.

**A.F. Amplifiers.**—In order to avoid distortion of the

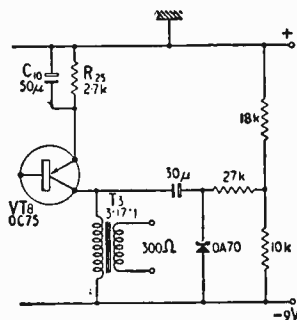

Fig. 3. Limiting circuit for removing residual "thump" signal in output stage.

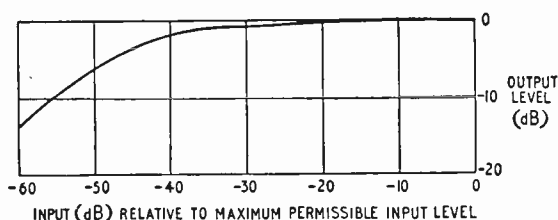

Fig. 4. Compression characteristic of constant-volume amplifier.

a.f. signal in the controlled stage, the a.f. level must be kept low, and therefore amplification of the compressed output from the secondary of T2 is necessary. VT7 and VT8 provide approximately 1mW maximum output in any convenient impedance, in the present case 300 ohms. Although the push-pull controlled stages remove most of the "thump" voltage from the signal up to the secondary of T2, the single-ended a.f. stage VT7 is driven to base cut-off on the positive half-cycle of its input by the very large transient signal which is applied after a pause in speech, when the gain of the VT1 and VT2 stages has risen to maximum. The large negative half-cycle at the base of VT7 is amplified and appears in the collector circuit of VT8 in the same phase. However, limitation of this half-cycle has already taken place in VT8 base circuit with the result that the initial transient in the collector circuit of this stage is only 6-10dB above the steady working level. In a practical application of this constant-volume amplifier used by the author, the effect was not considered bad enough to trouble about, but a simple peak limiting circuit as shown in Fig. 3 has been found effective in removing this small residual. The output signal using the above circuit modification is symmetrically limited to an r.m.s. power of approximately 1mW.

**Temperature Stabilization.**—The most vulnerable part of the circuit is the bias amplifier. Sufficient d.c. negative feedback has been applied to ensure adequate gain without serious shift of output stage working point over a temperature range from 0 to 40 degrees C, provided that transistors VT4, 5 and 6 have an  $\alpha'$  of not less than 40. There is a G.P.O. specification of a transistor of this type, but if this is not available it may be necessary to select from a batch of OC71 or GET3, or alternatively to use the OC75 which has an average  $\alpha'$  of 90 and will give excellent results in these positions.

VT1 and 2 stages are relatively unaffected by temperature due to the use of a low-value common-base resistor. The base return resistor  $R_4$ , together with the equivalent rectifier network resistance of MR1 and associated components, are low enough to ensure satisfactory operation of VT3 grounded collector stage over the fore-mentioned temperature range.

Lowering the ambient temperature towards freezing point tends to lower the gain of the bias amplifier especially when the transistors in the VT4, 5 and 6 positions have  $\alpha'$  in the region of 40. This drop is shown up as a worsening of the compression characteristic and hence as an increase in out-

put which masks the fall in gain of the a.f. amplifiers VT7 and VT8 at low temperatures. At high temperatures, the gain of the bias amplifier increases and the overall output falls, so that at 40 degrees C the maximum power output of the amplifier may fall to approximately 1/3 mW using average  $\alpha'$  transistors in VT7 and 8 positions and high  $\alpha'$  transistors ( $\approx 100$ ) in VT4, 5 and 6 positions.

The table summarizes the results obtained on the prototype using transistors of  $\alpha'$  as indicated.

Temperature Degrees C	Output change in dB for 30 dB input change when VT4, 5 and 6 have the following $\alpha'$ :—		
	VT4 } VT5 } = 40 VT6 }	VT4=74 VT5=62 VT6=50	VT4 } VT5 } = 100 VT6 }
0	4	0.6	3
20	1.5	0.5	2
40	1.3	0.7	2

**Input and Output Circuits.**—Unfortunately, due to the use of a controlled-gain amplifier of the variable input resistance type, the input impedance of the amplifier depends on the level of the input signal. Experiment has shown, however, that an average value of approximately 1k $\Omega$  provides a reasonable basis for transformer matching ratio calculation. With a 600 $\Omega$  input, an input transformer having the ratio 1.5:1+1 will be suitable. The output transformer in the model described was designed to feed into a 300 $\Omega$  load, but obviously it is quite a standard component. Transformer T2 may be bifilar wound on the primary side if desired, but this method of construction has not been used in the model described, since closely matched transistors have not been fitted in VT1 and VT2 positions. If a very accurate d.c. "thump" cancellation is required, it might be necessary to bifilar wind the transformer and provide separately adjustable bias supplies to VT1 and 2. This degree of refinement does not appear to be necessary judging from aural tests carried out with the constant-volume amplifier. Further, large "thump" voltages occur only after pauses in speech of 4-5 msec, the majority of "thump" signals consisting of small amplitude transients occurring between short pauses in speech or changes of input level, etc.

All the transformers have been designed for dealing with speech signals bandwidths only and thus have fairly low winding inductances.

The circuit of the 2.6 V bias battery must be broken when the main supply is disconnected in

Fig. 5. Overall frequency response of constant-volume amplifier.

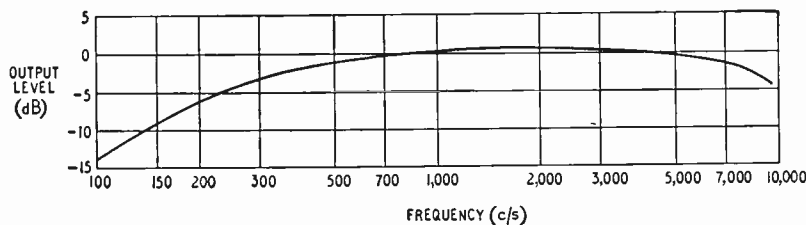



order to avoid excessive discharge through the various resistors across the supply.

In order to fully drive the constant-volume amplifier when a ribbon microphone is used, it may be necessary to use a simple single-transistor pre-amplifier. This course might also be adopted even when using adequate drive if the variations in impedance of the input circuit were required to be screened from the input signal source. However, this latter effect has not been found troublesome in applications of the amplifier used by the author. **Characteristics and Response.**—Fig. 4 shows the

compression characteristic of the amplifier. An isolating pad giving approximately 20 dB attenuation was inserted between the signal generator and the amplifier input in order to mask the input impedance changes which would otherwise upset the attenuator settings.

Fig. 5 shows the overall response which was measured with the bias amplifier inoperative, and a fixed voltage on the base of VT3.

The maximum input signal which the amplifier will handle without distortion depends to some extent on the transistors used, but is in the neighbourhood of 10-20 mV.

## Transmission-Line Exchange

AUTOMATIC INTERCONNECTION OF TRANSMITTERS AND AERIALS

THE problem, at a transmitting station, of interconnecting the transmitters and several different aerials is an old one and one to which there does not seem to be an easy answer. However, P. & L. Miller, Ltd., have recently completed two automatic transmission-line exchanges at the Royal Navy W/T station at Inskip, near Preston and the flexibility of each installation allows the connection of any ten transmitters—with outputs of up to 40kW—to any one of twenty aerials.

The transmitter outputs are carried on open wire balanced line to a 15-ft high "tower" at the centre of the semicircular exchange. From this tower there is an extension of each feeder line to a horizontally-traveling carriage, via a flexible feeder link, each carriage being at a different height. The carriages, which can be driven to any one of 21 preset positions by a "Teleflex" flexible drive system, have mounted upon them a pair of feed-through insulators bearing domed contacts on the side remote from the tower. Opposite 20 of the stopping points for the horizontal carriages, mounted on the other side of the framework, are 20 similar carriages capable of vertical movement, this time driven by a lead screw, to any of the ten levels at which the horizontal carriages travel. These vertically-moving carriages are connected through a hanging loop of flexible feeder to the outside aerial feeders and, when brought up to a horizontal carriage the contacts engage, so completing a feeder circuit between any one of the transmitters and any aerial.

Electric motors drive the carriages, and these are controlled from a panel in front of the exchange. On this panel are thirty sockets and ten internally-wired plugs, each plug

representing a transmitter. If a plug is removed from its "at rest" socket, when the transmitter carriage is parked in the twenty-first position with its feeder earthed, and placed in a socket corresponding to an aerial the following sequence of events takes place. First, the appropriate horizontal-drive motor is energized and the carriage travels round until it operates a micro-switch opposite the chosen aerial feeder. Then the horizontal motor is stopped by an electromagnetic brake, and the vertical drive is energized, similarly being stopped when the aerial-feeder carriage reaches the transmitter-line carriage. On returning the plug to its "at rest" socket the carriages return to their rest positions, with the transmitter feeder earthed and the aerial-feeder carriage below the arc of travel of the transmitter-feeder carriage on the lowest track.

The control system, which operates on 50V d.p. uses 440 micro-switches and six miles of cable, is interconnected with the transmitter interlock safety system. The drive motors are three-phase, 50-c/s, ¼-h.p. 1440-r.p.m. units using spur and helical gear reduction trains and each has a reversing contactor. The approximate weight of each exchange is about 8 tons.

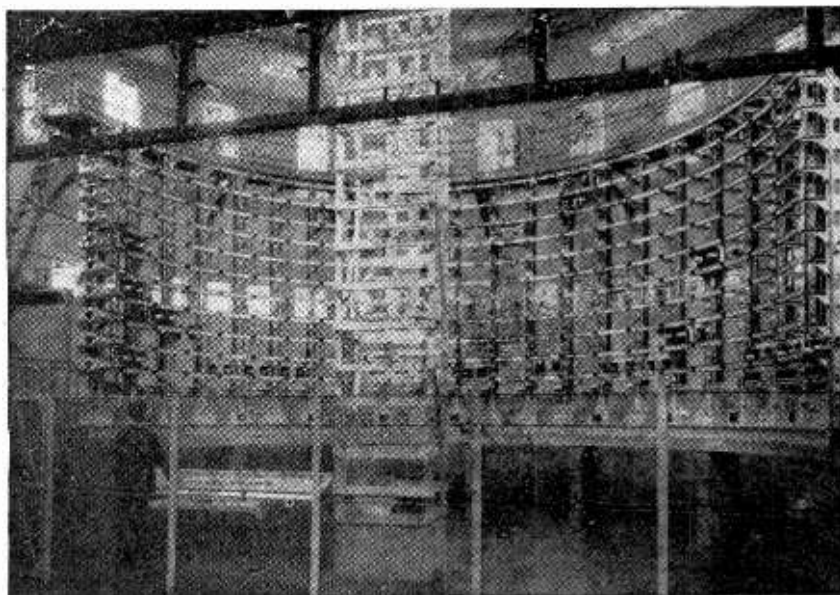

General view of the P. & L. Miller transmission-line exchange at Inskip R.N. W/T station, seen from back of tower to which flexible feeders are anchored.

# Manufacturers' Products

## NEW ELECTRONIC EQUIPMENT AND ACCESSORIES

### Artificial-echo Unit

IN the Binson Echorec artificial echoes are produced by magnetically recording the original sound and replaying it a suitable time later to form an echo. The signals are recorded on the magnetically-coated edge of a rotating disc and replayed through one or more of four fixed replay heads near the disc edge as the recorded signal on the disc edge passes under these heads. The replay heads are spaced apart from each other so as to provide four echoes at approximately 0.15-sec intervals from 0.15 to 0.6 sec after the original sound. An erase head erases signals as they pass under it, the total available continuous recording time on the disc being approximately  $\frac{1}{2}$  sec. Repeated echoes may be obtained if desired by feeding the replay heads' echo outputs back into the recording head so as to later produce echoes of the echoes. Such repeated echoes can be made to sound like reverberation. The echoes can also be made louder than the original sound so as to produce "swell" effects. The replay heads are spaced about  $2.5 \times 10^{-4}$  in from the edge of the disc and provide a response up to about 6kc/s. Echoes from any of as many as 12 different combinations of one or more of the four replay heads may be selected. Three other controls allow variation of the total time during which multiple echoes take place, as well as of the mean levels of both the echoes and the

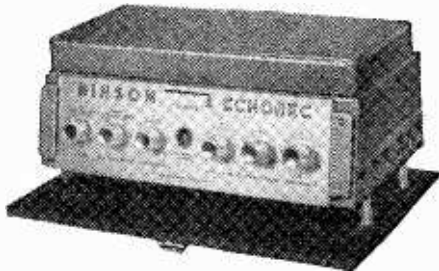

Binson Echorec artificial-echo unit.

original signal independently. Up to three different input signals can be accepted and processed together; alternatively, any of these inputs can be passed through unchanged. As many as six mains-voltage tappings from 110 to 280V are provided. The unit measures  $16\frac{1}{2} \times 11 \times 8$  in and weighs 28lb. It costs 140 guineas and is imported by Modern Electrics (Retail), of 164, Charing Cross Road, London, W.C.2.

### Wide-range Insulation Tester

SHOWN in the illustration is a completely self-contained portable insulation test set with the remarkably wide range of 200M $\Omega$  to 20 million megohms ( $2 \times 10^{10}\Omega$ ). Test voltages variable from 1 to 10kV are generated internally by means of a battery-operated transistor r.f. unit, step-up transformer and a voltage-multiplying stack of rectifiers.

Voltage and resistance measurements are read by a built-in valve-voltmeter with a large rectangular-faced microammeter directly calibrated in megohms (4 ranges) and in kilovolts (one range).

High-stability and "potted" components are used to ensure stability of operation under all conditions. The

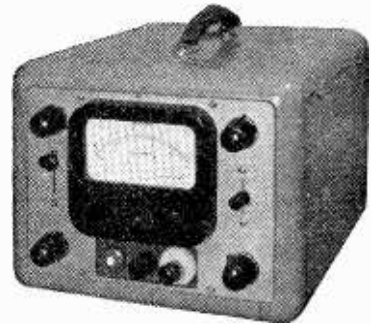

Miles Hivolt 20-million megohm insulation test set.

self-contained batteries are standard-type and easily replaceable.

The makers are Miles Hivolt, Ltd., 13 Mortimer Road, Hove 3, Sussex, and the price is £99 10s 0d.

### Band-pass I.F. Filters

FILTERS designed to fix the band-pass characteristics of v.h.f. communications receivers have been introduced by Salford Electrical, a subsidiary of G.E.C. Known as the Types 455KBP50 and 455KBP25 they provide the selectivity necessary to meet G.P.O. recommendations for use in communications systems of 50-kc/s and 25-kc/s channel spacing respectively. Both centre on an i.f. of 455kc/s with a frequency stability better than  $\pm 400$ c/s over the temperature range  $-20^\circ\text{C}$  to  $+70^\circ\text{C}$ .

The filters are completely encapsulated and enclosed in metal boxes. A brief specification of the 455KBP25 is as follows:—

Minimum bandwidth at $-6$ dB points . . . . .	16kc/s,
Maximum bandwidth at $-85$ dB points . . . . .	44kc/s,
Minimum out-band attenuation . . . . .	85dB,
Insertion loss . . . . .	12dB,
Termination resistance . . . . .	22k $\Omega$ .

They weigh approximately 1lb each.

The makers are Salford Electrical Instruments, Ltd., Pool Works, Silk Street, Salford 3, also at Magnet House, Kingsway, London, W.C.2.

Band-pass characteristic of Salford Type 455KBP50 i.f. filter.

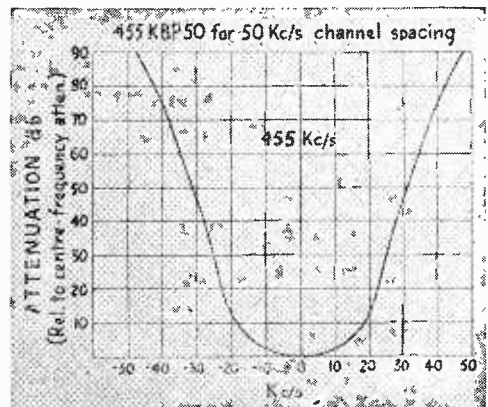

# Elements of Electronic Circuits

## 10.—TRIGGERED TWO-STATE CIRCUITS

By J. M. PETERS, B.Sc. (Eng.), A.M.I.E.E., A.M.Brit.I.R.E.

A WELL-KNOWN type of two-state circuit is the cathode-coupled multivibrator. The operation of this circuit is similar to that of the conventional multivibrator described in previous issues, and the same kind of cumulative action occurs. Fig. 1 shows the basic circuit, which is that of a two-valve

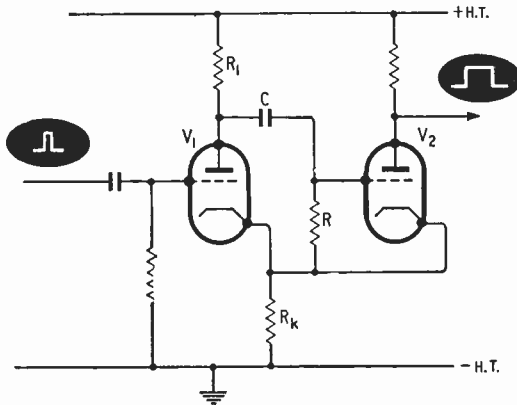

Fig. 1

amplifier with overall positive feedback, the valves being arranged in what is known as a "long-tailed pair" configuration.

A change in grid-cathode voltage gives rise to a series of events leading to a similar, but amplified, voltage variation being added to the grid-cathode voltage; hence the circuit is unstable and will under normal circumstances oscillate freely. However, if there is too great a bias difference between V1 and V2, the oscillations will stop and the circuit will

become stable with one of the valves non-conducting (see also the description of the operation of the "long-tailed pair," November, 1959, issue, p. 510). A suitable initiating signal to V1 grid will cause the circuit to perform a single cycle of oscillation. A freely running oscillator therefore becomes a trigger circuit.

Let us consider the operation of the circuit when the bias voltages are similar and when positive sync pulses are applied to V1 grid, see Fig. 2. Initially V1 is assumed to be cut off by V2, the grid and cathode of V2 being at the same potential. The anode current of V2 flowing through  $R_k$  produces the necessary voltage to cut off V1. A positive sync pulse of sufficient amplitude causes V1 to conduct, V1 anode voltage falls and is transferred to V2 grid by C.

Because anode current starts to flow in V1, the anode current of V2 will be reduced. The potential across  $R_k$  will fall but will be partly compensated by the rise in anode current of V1. Note: If the drop in anode current of V2 is greater than the rise in anode current of V1, then V2 will be cut off and V1 will continue to conduct.

With V2 cut off, V2 anode rises to h.t. C discharges through R and the conducting V1 until V2 grid rises through cut-off. V2 then conducts and V1 is cut off by the bias on  $R_k$ . C now charges through  $R_1$ , V2 and  $R_2$ ; thus the rise in the V2 anode waveform is curved. It will be noted that because the cathode potential can follow the grid potential during its positive excursion, no grid current flows. The grid waveform at V2 is therefore not squared by grid current as in the conventional multivibrator and it appears as a "differentiated" square wave.

No buffer amplifier is required with this method of connection since the sync voltage is isolated from

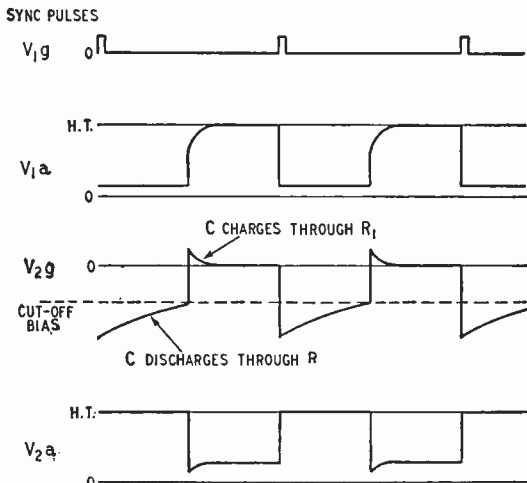

Fig. 2

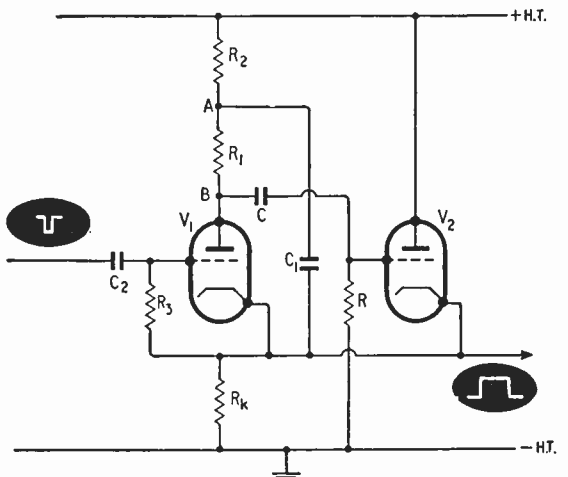

Fig. 3

the oscillatory circuit proper. Similarly, an undistorted square wave output may be taken from V2 anode without disturbing the action of the oscillator.

Fig. 3 illustrates a variation of the cathode-coupled multivibrator by which it is possible to obtain a large positive pulse output at the common cathode with a negative sync input. In the cathode-coupled multivibrator described above the positive pulse appears at the anode of V2 when V2 is cut off. In the Fig. 3 circuit V2 is conducting and the positive pulse appears at the cathode. By tying the cathode as well as the grid of V2 to the varying anode circuit potentials of V1 it is possible to add to the action of positive pulse generation, thereby obtaining a greater positive-going voltage than if the link were omitted. Such a connection, via  $C_1$  in the diagram, is called a "bootstrap" connection (derived from the notion of pulling oneself up by one's bootstraps—or boot-laces when in Britain).

The action is explained as follows. Let us assume that in the quiescent state V1 is conducting and V2 is cut off by the voltage developed across  $R_k$ . On the arrival of a negative sync pulse at the grid of V1 the anode voltage of V1 rises. V2 grid consequently

rises and V2 starts to conduct. In so doing, however, it increases the common cathode potential, thereby cutting off V1.

The positive-going cathode voltage is back-coupled to point A in Fig. 3 via  $C_1$ . (To avoid any distortion of the pulse a long time constant "bootstrap" coupling circuit  $C_1R_2$  is used.) From A the positive going voltage is transferred and added to that appearing at B, and thence back to V2 grid via C. The further increase in current in V2 results in a further rise in cathode potential. This is the "bootstrap" action, for because of the coupling via  $C_1$ , the resultant positive-going output voltage is very much greater than the positive going voltage initially developed across  $R_1$ .

It will be noted that any change in voltage across  $R_1$ , i.e. between A and B, will be applied between V2 grid and V2 cathode. V2 therefore acts fully as an amplifier without negative feedback and not as a cathode follower. The period which must elapse before the circuit resets is dependent on the time constant of the grid circuit of V1 (principally  $C_2R_3$ ). When V1 grid approaches the cathode potential, V1 again conducts, thus continuing the action.

## Vacuum Encapsulating Plant

SHOWN in the illustration is a self-contained plant developed primarily for vacuum encapsulation of radio and electronic components. This model, the Type VP200, consists of a cylindrical work tank assembled alongside a control unit in which is housed the motor-driven vacuum pump, low-voltage mains transformer, d.c. rectifiers, silica gel air driers, vacuum gauges and all

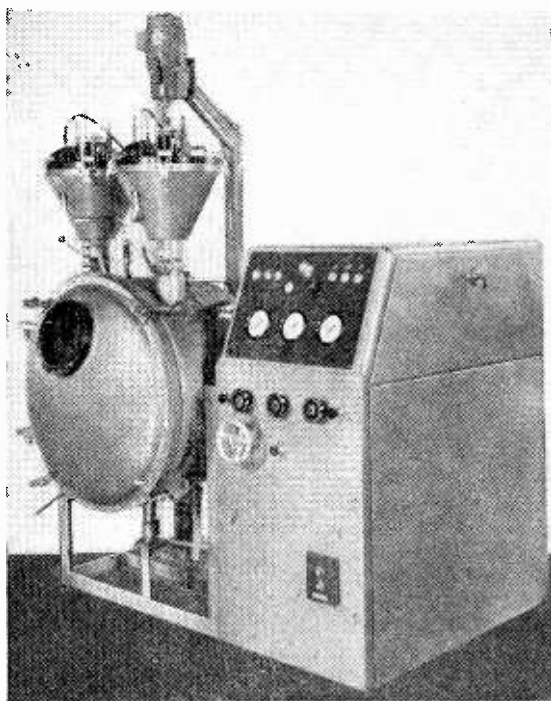

Self-contained plant for vacuum impregnating and encapsulating radio and electronic components.

switches and controls necessary for the operation of the plant.

Two conical-shaped hoppers are mounted on top of the work tank in which the epoxy or polyester "potting" resins are mixed, two being provided so that mixing can be done in one while the other is being poured into the moulds. Each hopper holds about 80 fluid oz of resin and is independently evacuated, heated and thermostatically controlled. Mixing is effected by a rotating vane driven by a variable-speed motor and mounted on a swinging arm so that the vane can be dropped into either hopper.

Access to the work tank for "loading" is by means of a domed end-door secured by six quick-action clamps. The tank is hermetically sealed when the door is closed and can be evacuated down to 1mm Hg in a little over 5 minutes. A 9-in glass inspection window enables the various moulds to be positioned below the pouring nozzles and the filling process observed and controlled.

Inside the work tank is an electrically heated and thermostatically controlled work turntable on which the moulds are placed. It has about 600 sq in of work space and will carry 240 lb of distributed load. It is rotated by means of a handwheel on the control unit.

Eventually it is proposed to produce the plant in various sizes and work is in hand on automatic plant for high rates of production. Further details can be obtained from Pipework and Engineering (Bristol), Ltd., Stanley Street South, Bristol, 3.

**Talking Books**—Tribute is paid in the annual report of the Royal National Institute for the Blind "to the two thousand amateur radio and sound recording enthusiasts throughout the country who render such magnificent help in servicing the [talking book] machines." Reference is also made to the voluntary transcribers who add each year some 1,000 Braille volumes, each hand embossed, to the students' library. Among them are a number of radio textbooks. These are, of course, in addition to the regular supply of mechanically embossed periodicals and books maintained by the Institute.

Omnis definitio periculosa est  
(Every definition is dangerous)

ERASMUS

# IMPEDANCE

By "CATHODE RAY"

It is quite a thought that after 25 years of Cathode Radiation such a basic and elementary subject as impedance can still be found which (a) has not previously come under the beam, and (b) is sufficiently controversial. Yet so it is.

What started it off was my discovery that the meaning of impedance could provide material for argument in the pages of the *Journal of the Institution of Electrical Engineers* to a degree that the correspondents became quite heated—one might almost say personal—while other and cooler minds found in it an occasion for a vivid display of incomprehensible mathematics, bringing in such apparently (to me) unrelated matters as entropy and explosion.

Admittedly the subject discussed was actually *negative* impedance, but it began in the very first paragraph with the British Standard definition\* of impedance:

"The ratio of the r.m.s. electromotive force in a circuit to the r.m.s. current which is produced thereby. Symbol: Z."

R. O. Kapp, Emeritus Professor of Electrical Engineering, University College, London, has said that physicists (in contrast to philosophers, who begin with names for their concepts before they have agreed on what the concepts themselves are) begin with precise concepts, then define them, and lastly standardize names and symbols for them. And, this being so, the definition is not quite as important as we thought it was, since it is needed more for identification of a concept which we are all supposed

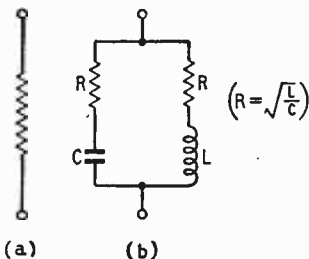

Fig. 1. (a) is a particular kind of impedance that is obviously independent of frequency. Though this is less obvious with (b), it too amounts to exactly the same thing.

the eye. We may be prepared to believe that detailed conditions might be left out of such definitions, on the ground that they are so commonly assumed that including them would look pedantic, as well as putting up the price of the publication. But the definers would hardly throw in an expression like "r.m.s." without due thought, just to give their work an air of distinction. And if this definition were meant to be confined to cisoidal waveforms (that is the currently favoured term, I believe, embracing pure sine or cosine forms) there would be no point in limiting it to r.m.s. values—peak values, or any fraction or multiple thereof, would do just as well, since any factor applying to both e.m.f. and current would cancel out on taking the ratio. Therefore, giving the definers the benefit of serious doubts raised on other occasions and assuming they were rational beings, we can infer that their definition of impedance is valid for any waveform.

## Principle of Dependency

Your first reaction to this may be the same as mine was—to object. "Why!" you may exclaim, "most circuits would have quite different impedances to the separate components of, say, a square-wave e.m.f., so the value of Z would depend on what the waveform happened to be!" But after a little thought we can meet this objection with the retort "So what?" For even where the waveform is purely cisoidal and the details of the circuit are fully specified, its impedance is still (apart from a few special cases such as in Fig. 1) quite unknown—it depends on frequency. The principle of dependency having already had to be conceded, why worry because Z depends also on waveform? And having given way so far, surely no one is likely to make a stand against impedance being allowed to depend on yet another parameter of the applied e.m.f.—amplitude. So there is no need to bar non-linear circuits such as iron-cored coils.

Transients are different, though. An r.m.s. value being by definition not an instantaneous value, it implies a steady state.

So, if I interpret the collective mind of the relevant B.S. committee aright, their definition of impedance holds for any waveform and any circuit, but not for transients.†

Offhand, I suspect that not many people in our field take much advantage of this liberal interpretation of impedance. For one thing we seldom have the equipment for measuring the true r.m.s. values of signals. And we tend to regard impedance as a function only of frequency and to analyse non-cisoidal waveforms into their Fourier components for separate consideration. (We shall see one reason why in a minute.) I'm not very well up in high-power

†This appears to hold good on the other side of the Atlantic, for Henney's "Radio Engineering Handbook," 5th edition (1959), p. 1-107, defines impedance in practically the same way as B.S., and goes on to apply it specifically to non-cisoidal e.m.f. and current.

\*B.S.205: Part 1: 1943, Definition 1282.

radio transmitter practice, but perhaps in that sort of work—and anywhere in which bolometers and other heat-operated measuring instruments are used—it is useful to know the impedance of a circuit to a given non-cisoidal e.m.f. for calculating how much heating current will flow therein.

The next thing is to point to the distinction between impedance (as hereinbefore defined) and impedance operator. I might have hesitated to do this, feeling that it verged on insulting the intelligence, had it not apparently been one of the causes of the confusion in *Jour. I.E.E.*, in spite of its high-class professional standing. So it must be emphasized that impedance, according to the B.S. definition, is just a number of ohms, which by itself reveals nothing of the phase angle between the e.m.f. and current. That comes as a separate piece of information. And right away that restricts one to cisoidal waveforms and linear circuits. For unless the e.m.f. is cisoidal and the impedance is linear, the

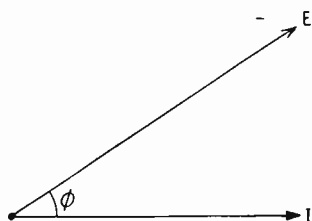
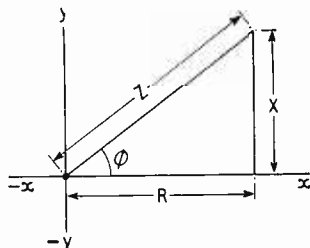

Fig. 2. The familiar vector method of representing the phase difference between e.m.f. and current.

Fig. 3. Showing how a distance Z can be set off at any angle on squared paper (not primarily adapted for angles). Vertical or y-axis measurements (X) are distinguished from horizontal or x-axis (R) by the prefix j.



resulting current has—in general—a different waveform. And unless the current and voltage waveforms are identical it is not possible to identify the phase difference between them. And just knowing Z without its phase angle is seldom enough.

It is true that it does enable the current to be calculated, given the e.m.f., in the same manner as in “Ohm’s law”:

$$I = \frac{E}{Z}$$

Or the inverse:

$$E = IZ$$

And it is true that the impedance of a loudspeaker is often given just in ohms. But one can’t calculate the power an amplifier can deliver to it without knowing or at least assuming its phase angle,  $\phi$ .

There are quite a lot of different ways of taking account of  $\phi$ . They are explained in any worth-while book on a.c. theory, and all that is needed here is a few words on the impedance operator. It is a mathematical concept, in contrast to impedance, which is a physical concept. It ties up with the representation of cisoidal currents and voltages by vectors (though physically they are not vector quantities, in circuits, anyway). For example, Fig. 2 represents the e.m.f. E in a circuit and the current I due to it. The value

of E can be found by multiplying I by the impedance Z. But that leaves the phase relationship unknown. If the angle  $\phi$  is also given, we have the whole story (for one particular frequency). Mathematical minds like to think of the process of arriving at the full information about the e.m.f. as operating on the current vector by the complex impedance operator **Z** (in heavy type to distinguish it from Z), specified by Z and  $\phi$  combined. What this operator does to I in order to arrive at E is to alter its length (multiplying it by Z) and to rotate it positively (anticlockwise) through the angle  $\phi$ .

One way of specifying **Z** is by what are technically called its modulus and argument; in other words, the magnitude Z and the phase angle of the vector E relative to the vector I, usually denoted by  $\phi$ . (If I leads E, as it does in a capacitive impedance,  $\phi$  turns out to be negative.) For example, **Z** might be  $700\Omega \angle +40^\circ$ . This is the polar presentation, because it uses polar co-ordinates—radius and angle.

But angles don’t fit directly into algebra; nor on squared paper, which is made for cartesian co-ordinates—x and y. The only angle that can be said to fit into ordinary algebra is  $180^\circ$ , because that can be represented by a minus sign. It reverses the direction along a scale of values, say the x axis of a graph. What is called complex algebra extends this to include right angles. Quantities to be measured along the y axis are distinguished from those along the x axis by the prefix j. This scheme provides two dimensions, so that a distance can be specified in any direction on a graph and not only along one axis, by prescribing the appropriate numbers of units to be taken horizontally and vertically. So this is an alternative two-part specification for an angle. In the case of impedance, the x distance is what we know as resistance, and the y distance as reactance (Fig. 3). And so we have the well-known relationship

$$Z = R + jX$$

(It may be a little confusing for beginners that the symbol for reactance, which is measured along the y axis, is X; but that is just one of those things to keep them alert!)

Quite often one does actually measure impedance by measuring X (or L and C, which are related to it) and R, in which case this second form is obviously appropriate. Sometimes there is a need to change over between it and the first.  $\tan \phi$  is  $X/R$ , so  $\phi$  is the angle whose tangent is  $X/R$  (written  $\tan^{-1} X/R$ ) and can be found, knowing X and R. And our old friend Pythagoras, looking at Fig. 3, tells us that  $Z = \sqrt{R^2 + X^2}$ .

With the further help of trigonometry it is possible to work in terms of  $\phi$  and Z even on a cartesian framework.  $\sin \phi$  is  $X/Z$  and  $\cos \phi$  is  $R/Z$ , and  $Z = R + jX$ . Putting these together we get

$$Z = Z(\cos \phi + j \sin \phi)$$

In this, where Z of course is the magnitude of the

(Continued on page 97)

Fig. 4. If the length of the radius is 1 unit, its horizontal and vertical components are numerically equal to the cosine and sine of the angle  $\phi$ .

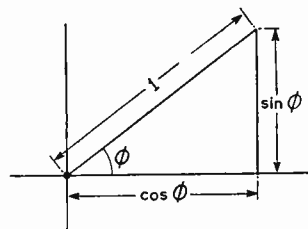

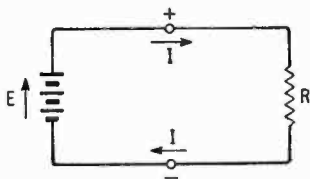

Fig. 5. Looking from R, the generator appears to be a negative resistance (not an ohmic one in this case!) because I is flowing against the voltage across R.

impedance, its phase angle is given in along-and-up terms by  $(\cos \phi + j \sin \phi)$ . This can perhaps be seen even more clearly in Fig. 4, where a radius is drawn of length 1. The lengths of the two other sides of the right-angled triangle are, by trigonometrical definition, equal to  $\cos \phi$  and  $\sin \phi$ . So " $\cos \phi + j \sin \phi$ " means "move along a distance equal to  $\cos \phi$  and upwards a distance equal to  $\sin \phi$  (downwards if  $\sin \phi$  happens to be negative)" and the total result is a unit-length radius rotated from the x axis position through the angle  $\phi$ . Multiplying  $(\cos \phi + j \sin \phi)$  by the number Z gives an operator which multiplies the unit radius by Z as well as rotating it through  $\phi$ . The whole operation is what is meant by Z. If used on an I vector the result is an E vector.

There is a fourth mode of expression which is quite often useful, but which is much less easily explained. In fact, it looks at first sight quite nonsensical, and if I explained it on the same elementary level it would leave no room for any more about impedance, so I will merely mention that an alternative mathematical form for  $(\cos \phi + j \sin \phi)$  is  $e^{j\phi}$ . It is derivable from the series forms of  $e^x$ ,  $\sin \phi$  and  $\cos \phi$ . Besides its welcome brevity, it is handy where multiplication or division has to be done, because those operations are performed simply by adding or subtracting indices.

## Negative Impedance

Lastly we come to negative impedance; is there such a thing? Apparently feelings run high on the question. I'll try to put it objectively. We start with resistance, which is anything that needs an e.m.f. to drive current through it in phase with the e.m.f.—which means that the current always goes through it from positive terminal to negative. It absorbs power from the source or generator of the e.m.f. This is the situation viewed from the generator and looking into the resistance, which is a load on it. But suppose we turn round and look from the load into the generator. We see that the current is flowing through it from negative to positive (Fig. 5). This, being the reverse of what we saw when looking at the load resistance, is logically called a negative current, and so the resistance we are looking into must be a negative one.

That is quite a useful concept in connection with positive-feedback amplifiers, which when connected to suitable loads can generate alternating currents, or at least reduce load resistance already present. It is logical and convenient to regard such amplifiers as negative resistances. True, the practice has its little pitfalls, which ran to two instalments of "Cathode Ray" in January and February 1957. But I don't know of anyone who seriously objects to this concept in principle.

It is when the concept is extended to the wider range of impedance, as is sometimes done in America at least, that objection is aroused. I would expect the argument for negative impedance to arise from the fact that the current in an a.c. circuit is only

exceptionally in exact phase or antiphase with the e.m.f. So if one connects to a "black box" and finds that current flows out of it—i.e., from its positive terminal—but not exactly  $180^\circ$  out of phase with the voltage, we may be tempted by analogy with negative resistance to call the contents of the box a negative impedance. It sounds plausible, but does it fit what has already been agreed about impedance?

The B.S. definition takes no account of the signs or directions of the e.m.f. and current whose ratio is declared to be impedance. So no sign attaches to that impedance. It is just a number of ohms—the ratio of a number of volts to a number of amps. Why is this, seeing that it is common practice to give a sign to resistance to show whether it is taking or delivering power, indicated respectively by positive and negative conventional direction of current in relation to applied e.m.f.? There is a very good reason. The current through an impedance, *except when that impedance is a pure resistance*, is neither exactly in phase nor antiphase with the e.m.f., so its relationship with the e.m.f. cannot be indicated simply by + or -. During part of each cycle the current is flowing with the e.m.f. and during the remainder against it—whether the impedance is on balance a load or a generator. Fig. 6 shows examples of both, in waveform and vector representations.

"Very well then," the negative-impedance advocate might say; "let's define negative impedance as impedance in which the resistive component is negative. What's wrong with that?"

Well, it would certainly seem to be the most logical definition. But one or two difficulties arise. First, we are obliged to say what we are going to do about impedances which on this basis are neither positive nor negative: pure reactances. Impedance being an all-embracing term, including pure reactances and resistances, this lands us with an anomaly for a start. The fog thickens when we consider that reactances themselves are conventionally either positive or negative. In Fig. 6(b) the resistive component is negative and so is the reactive component.

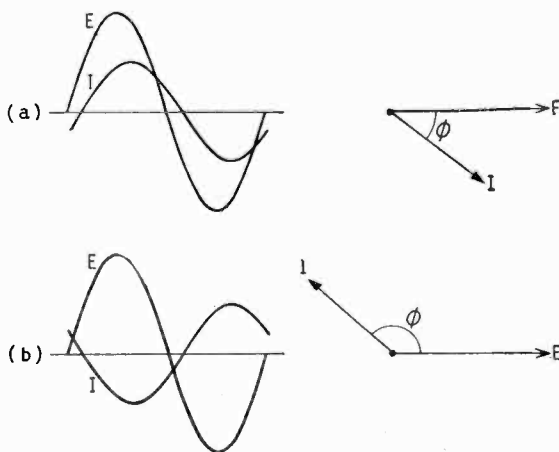

Fig. 6. Unless an a.c. is exactly in phase or antiphase with the e.m.f. there are parts of every cycle when it is flowing with and against the e.m.f., whichever way the net power flows.

The latter would be positive if  $\phi$  were more than  $180^\circ$ . That real confusion arises from this is demonstrated unintentionally by Dr. B. R. Myers, who speaks up in *Jour. I.E.E.* for negative impedance, when he says "The only time I have seen the term 'negative impedance' misused is in connection with impedances whose real parts were negative. The latter are negative impedances only when their imaginary parts are negative reactances." ("Real" and "imaginary" refer to resistive and reactive components respectively.) So here we seem to have quite a different idea of negative resistance—one in which the reactive part is negative (capacitive). An arguable one, I suppose; but I should have thought that on the whole the direction of power flow was more important than whether the reactive part was positive or negative. One would, I think, tend to regard negative impedance as an extension of the idea of negative resistance rather than of negative reactance (which one more often calls capacitive reactance).

Not only do the negative-impedance advocates have to choose between one or other of the component parts of impedance to decide the sign of the whole (and probably divide into two schools of thought about it); they upset existing definitions and conventions, which sensibly (it seems to me) take the line that attaching a + or - to a complex quantity is an over-simplification, and it is better to use either the simple ratio (as in the B.S. definition) or go the whole hog by specifying the actual phase angle (as in the various forms of the impedance operator).

### Condemnation

I therefore side with Mr. M. O. Williams, who first raised the matter by condemning "negative impedance." As for the consortium of B.B.C. brains who intervened, I'm so far from understanding their mathematical reasoning and its somewhat

bizarre conclusions that I'm not even sure which side they finally come down on. It consoled me considerably to learn that my bewilderment was shared by no less an authority than Prof. Kapp. But I suspect that as regards negative impedance they too are agin' it.

Further research into American literature (especially three articles by E. L. Ginzton in *Electronics*, July-Sept. 1945) has led me to suspect that the interpretation which Mr. Williams (presumably) and I (certainly) put on the quoted remark of Dr. Myers was quite wrong, and no wonder, for it seems that Dr. Myers and the few (let us be optimistic!) who take the same line about negative impedance have been as naughty as motorists who take a sudden turn on a crowded road without warning. Ignoring the long established convention (in U.S.A. as well as G.B.) that positive reactance means inductive reactance and negative means capacitive, they use the term negative reactance to mean a reactance which is either inductive or capacitive but varies with frequency like the opposite kind. Their "negative inductive reactance" increases directly with frequency but is capacitive (*negative* by standard convention, with current leading e.m.f.) and their "negative capacitive reactance" increases inversely with frequency like an ordinary capacitive reactance but is inductive (*positive* by standard convention, with current lagging e.m.f.). And "negative impedance" covers these elements along with negative resistance. The spokesmen for this curious perversion have not been remarkable for the openness and lucidity of their expositions, but as well as I can make out the foregoing is the basis of their creed.

By way of illustration I have been trying hard to think of any small arbitrary departure from common usage which would naturally tend to cause more confusion, but have had to give up. Perhaps that is the most sensible thing to do with the negative-impedance sect.

## FEBRUARY MEETINGS

*Tickets are required for some meetings; readers are advised therefore to communicate with the secretary of the Society concerned.*

### LONDON

2nd. I.E.E.—"Development of the formulae of electromagnetism in the M.K.S. system" by Dr. P. Vigoureux supported by "The choice of basic dimensions in electromagnetism" by P. C. M. De Belatini at 5.30 at Savoy Place, W.C.2.

5th. I.E.E.—Medical Electronics Group discussion on "Computers in medical use" opened by Dr. R. A. Buckingham and Dr. J. M. Tanner at 6.0 at Savoy Place, W.C.2.

5th. Television Society.—"Automatic control systems in television receivers" by K. E. Martin and P. L. Mothersole (Mullard Research Labs.) at 7.0 at the Cinematograph Exhibitors' Association, 164, Shaftesbury Avenue, W.C.2.

8th. I.E.E.—Discussion on "Present views on ground-wave propagation" opened by G. Millington at 5.30 at Savoy Place, W.C.2.

9th. Brit.I.R.E.—"Drift correction of d.c. amplifiers" by D. Leighton Davies at 6.30 at the London School of Hygiene and Tropical Medicine, Keppel Street, W.C.1.

9th. Radar & Electronics Association.—"Transistors today and tomorrow" by E. Wolfendale (Mullard) at 7.30 at the Royal Society of Arts, John Adam Street, W.C.2.

17th. I.E.E.—Faraday Lecture on "Electrical Machines" by Professor M. G. Say at 6.0 at Central Hall, Westminster, S.W.1.

17th. British Kinematograph Society.—"Modern television studios" by W. H. Cheevers (Associated-Rediffusion) at 7.30 at the Colour Film Services Ltd. Theatre, 22-25, Portman Close, Baker Street, W.1.

19th. Institute of Navigation.—"Space navigation" by Dr. J. G. Porter (Royal Greenwich Observatory) at 5.15

at the Royal Geographical Society, 1, Kensington Gore, S.W.7.

19th. B.S.R.A.—"The sounds of music" by Dr. W. H. George at 7.15 at the Royal Society of Arts, John Adam Street, W.C.2.

22nd. I.E.E.—Discussion on "Are we making the best use of research resources?" opened by L. Rotherham at 5.30 at Savoy Place, W.C.2.

23rd. I.E.E.—Discussion on "Courses for electrical technicians" opened by Professor M. W. Humphrey Davies at 6.0 at Savoy Place, W.C.2.

23rd. Society of Instrument Technology.—"Back-scatter method of wall thickness measurement" by D. F. White and L. E. Taylor and "Ultrasonic resonance method of wall thickness measurement" by M. V. James at 7.0 at Manson House, 26, Portland Place, W.1.

24th. Royal Society of Arts.—True-man Wood Lecture, "The exploration of outer space" by Professor A. C. B. Lovell (Manchester University) at 2.30 at John Adam Street, W.C.2.



## FEBRUARY MEETINGS (contd.)

24th. I.E.E.—“Applications of microwaves” by Professor A. L. Cullen at 5.30 at Savoy Place, W.C.2.

24th. Brit.I.R.E.—“The unification of electronic clinical instruments” by Dr. F. D. Stott at 6.30 at the London School of Hygiene and Tropical Medicine, Keppel Street, W.C.1.

25th. Television Society.—“Science on television” by A. J. Garratt (International Scientific Research Exhibitions) at 7.0 at the Cinematograph Exhibitors' Association, 164 Shaftesbury Avenue, W.C.2.

### BIRMINGHAM

17th. Institution of Production Engineers.—“The application of computers to production control” by R. G. Hitchcock at 7.0 at the James Watt Memorial Institute.

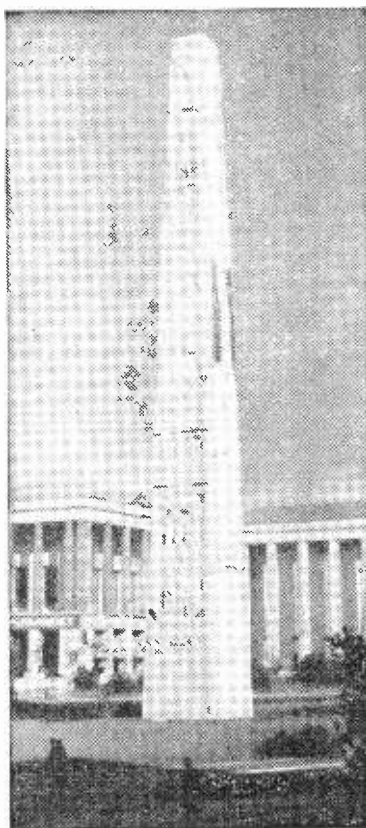

“Marconi Antenna” is the name given to this obelisk recently unveiled by Marconi's widow in the grounds of Permindex, the new world trade centre in Rome. Fifteen bas-relief panels depict incidents in the life of Marconi. A miniature gold reproduction of the obelisk and a diploma will be awarded each year from 1960 by the Centre to the person making “the greatest contribution to the progress and development of the ideas and discoveries of Guglielmo Marconi, in any field of human endeavour”

### BOURNEMOUTH

8th. Association of Supervising Electrical Engineers.—“Television engineering” by a member of Southern Television at 8.0 at the Grand Hotel, Firvale Road.

### BRISTOL

24th. Brit.I.R.E.—“Industrial magnetic recording and playing machine design” by J. Elliot at 7.0 at the School of Management Studies, Unity Street.

### CARDIFF

10th. Brit.I.R.E.—“Low noise, low drift d.c. amplifiers” by V. L. Devonald at 6.30 at the Welsh College of Advanced Technology.

25th. British Computer Society.—“Basic principles of programming—part II, by Dr. R. J. Ord-Smith (S.T.C.) at 6.30 in the Small Shanlon Lecture Theatre, University College.

### HALIFAX

3rd. Association of Supervising Electrical Engineers.—“Transistors” by a member of G.E.C. at 7.45 at The Crown Hotel, Horton Street.

### HULL

10th. British Computer Society.—“ERNIE the electronic random number indicator” by W. E. Thomson (Post Office Research) at 7.30 at the Hull Chamber of Commerce, Samman House, Bowlalley Lane.

### LIVERPOOL

2nd. Brit.I.R.E.—“Distribution of sound and television by wire” by A. W. Mews, at 7.0 at the University Club.

### MALVERN

2nd. Brit.I.R.E.—“Electronics in medical and biological research” by W. J. Perkins at 7.0 at Winter Gardens.

### MANCHESTER

4th. Brit.I.R.E.—“Acoustics in modern buildings” by E. S. Benson at 6.30 at Reynolds Hall, College of Technology, Sackville Street.

22nd. Institution of Production Engineers.—“Radio in space research” by Dr. J. A. Saxton at 7.15 at Reynolds Hall, College of Technology, Sackville Street.

### NEWCASTLE-UPON-TYNE

2nd. British Computer Society.—“Data transmission in relation to computers and data processing systems” by W. S. Ryan (G.P.O.) at 7.0 at the University Computing Lab., 1 Kensington Terrace.

10th. Brit.I.R.E.—“Instrumentation in rocket propulsion” by R. E. Ross at 6.0 at the Institution of Mining and Mechanical Engineers, Neville Hall, Westgate Road.

### OXFORD

16th. Association of Supervising Electrical Engineers.—“Radio astronomy” by Dr. A. D. Petford (Oxford University, Observatory Section) at 8.0 at the Employment Exchange.

### SHEFFIELD

1st. Society of Instrument Technology.—“Feedback—the principle of control” by R. S. Medlock (president) at 7.0 at The University, St. George's Square.

### WOLVERHAMPTON

10th. Brit.I.R.E.—“Electronic reading” by I. W. Merry at 7.15 at College of Technology, Wulfruna Street.

## Two Trix models

PROVED  
and  
IMPROVED

### COLUMN TYPE LOUDSPEAKER

An all-round improvement in acoustic efficiency, permitting smaller powered amplifiers ... a distinct directional flat beam effect extending coverage while sharply reducing reverberation and feedback effects. One Trix column replaces with greater efficiency a large number of normal speaker units with a corresponding reduction in installation costs. For all sound installations superb clarity of reproduction is assured for both speech and music.

Write for detailed technical information.

### RIBBON MICROPHONE

Now smaller, this new design gives improved performance, minimizing feedback effects while improving frequency response and sensitivity.

Model G7823 is complete with screened connector plug and locking ring and beautifully finished in satin chrome. A silent switch adaptor G7819 is also available.



# TRIX

THE TRIX ELECTRICAL CO. LTD.,  
1-5 MAPLE PLACE, LONDON W.1.

Tel: MUSEum 5817 (6 lines)  
Grams: Trixadio Wesdo London

# RANDOM RADIATIONS

By "DIALLIST"

## What's in a Name?

AN area secretary of the Association of Radio and Electronic Engineers takes me to task for calling those who repair our sound and television sets servicemen. "This," he writes, "seems to fit with milkman and lavatory man." He would prefer service engineer. Well, I'm the last person ever to hurt anybody's feelings if I can help it; but I think he's quite wrong in suggesting that there's anything derogatory about "man." Think, for instance, of sportsman, Government spokesman, nobleman, Chairman and so on. Myself, I've no objection at all to being called a writing man. In France the people who see to sound radio and TV sets, record reproducers and the like are called *dépanneurs*, which means simply those who put right *pannes*, or break-downs, and no one is offended by the term. I know, of course, the modern tendency is to use high-falutin titles; the rat catcher is a rodent operative, the dustman a refuse collector and even office boys are now "junior male management trainees"!

## Hard to Define

It's not an easy business to define the meaning of "engineer" as the word is used in this country. Lots of people have had shots with varying

success. There's no doubt that corporate members of our senior engineering institutions are engineers, chartered engineers in fact. But that by no means exhausts the list. I think I'd say that an engineer is one whose high qualifications, long learning and wide knowledge of his particular branch fit him to originate, to design, to co-ordinate and to direct. That, though, may be found too sweeping by some. To come back to the world of wireless, an alternative to "serviceman" might be "service technician," but that seems to me rather too much of a mouthful. If any readers care to send suggestions, they'll be most welcome. I'd be only too happy to find a concise term that is acceptable all round and doesn't cause any hackles to rise and at the same time isn't too pretentious. Give me that and I'll erase "serviceman" from my vocabulary.

## No "Out-of-Stock" Here

THOSE well-known component manufacturers, A. F. Bulgin & Co., have just made a rather remarkable announcement. Under the heading "Continuity of Supply" they state: "Tools are stored and maintained for the future replacement of components shown in all our catalogues during the last 25 years." Now, that really is the stuff to give the troops and I hope that other makers will

follow this excellent example. Few things are more exasperating than to find when some indispensable component in an expensive piece of apparatus packs up that replacements are no longer available. I expect most of us have had the sad experience. Well done, Bulgin's; that can't happen with your products.

## Non-standard Colour Coding

THE I.E.E., I'm glad to see, has issued a warning about imported apparatus provided with triple flex leads which don't conform to our standard colouring. I'd no idea that so many different systems were in use on the Continent until I read an article on the subject by Philip Honey in *Wireless & Electrical Trader*. Germany uses red-covered earth leads, but in Holland they are grey, in Belgium black and in Switzerland yellow. Phase leads can be red, yellow or blue in Belgium, grey (as a rule) in Germany, and any colour but red or grey in Holland. Neutrals are usually grey or black, though in Holland they're red. Well, there's a fine mix-up for you! I suppose that apparatus imported from Germany with its red earth and grey phase leads is by far the most dangerous, for if a 3-pin plug were connected in our fashion to the leads, all metal parts that should be earthed would be at the full mains potential. But Grundig (Gt. Britain) Ltd. have already announced that the colour codings of all their machines with 3-core mains leads conform to the standard British practice.

Any dealer should verify that the colours mean what they suggest to British eyes before putting imported apparatus on sale, and purchasers would be well advised to obtain an assurance on this point. As it is, a number of people have received shocks, though I'm happy to say that no fatalities have been reported and I sincerely hope they won't be.

## Approved Electrical Appliances

IT'S good to read that after discussions extending over a considerable time the electricity supply industry, the British Electrical and Allied Manufacturers' Association and the



## "WIRELESS WORLD" PUBLICATIONS

	Net Price	By Post
RADIO DATA CHARTS. R. T. Beatty, M.A., B.E., D.Sc. Revised by J. Mc. G. Sowerby, B.A., A.M.I.E.E. 5th Edition	10/6	11/6
TELEVISION RECEIVING EQUIPMENT. W. T. Cocking, M.I.E.E. 4th Edition	30/-	31/9
TRANSISTOR A.F. AMPLIFIERS. D. D. Jones, M.Sc., D.I.C., and R. A. Hillbourne, B.Sc.	21/-	21/10
LONG-WAVE AND MEDIUM-WAVE PROPAGATION. H. E. Farrow, Grad.I.E.E.	4/6	4/10
RADIO CIRCUITS: A Step-by-Step Survey. W. E. Miller, M.A. (Cantab.), M.Brit.I.R.E. Revised by E. A. W. Spreadbury, M.Brit.I.R.E.	15/-	15/10
GUIDE TO BROADCASTING STATIONS. 12th Edition	3/6	4/-
PRINCIPLES OF TRANSISTOR CIRCUITS. S. W. Amos, B.Sc. (Hons.), A.M.I.E.E.	21/-	21/11
MICROWAVE DATA TABLES. A. E. Booth, M.I.R.E., Graduate I.E.E.	27/6	28/8
PRINCIPLES OF FREQUENCY MODULATION. B. S. Camies	21/-	21/10

A complete list of books is available on application.  
Obtainable from all leading booksellers or from

ILIFFE & SONS LTD., Dorset House, Stamford Street, London, S.E.1

British Standards Institution have formed a provisional board to manage a national organization for the approval of domestic electrical appliances. The board has been instructed to organize as quickly as possible machinery for safeguarding the British public by approving electrical appliances and publishing lists of those approved. All approved goods will carry a distinctive mark. The scheme is open to all domestic electrical gear manufactured here or imported, and one of the aims is to encourage people to buy only approved goods bearing the special mark. A pity that the plan wasn't in force before those appliances whose triple flex leads don't conform to our standard were imported.

### F.M. in France

WRITING from Aylesbury, a reader tells me that he has been able to receive the f.m. transmissions from Caen ever since they started, and that he has noticed the poor quality to which I referred a month or two ago in these notes. I'd have been inclined to put the shortcomings down to multi-path reception but for the fact that he writes that he regularly receives some of the West German stations and that the quality of their transmissions is superb. His view is that the French broadcasting engineers are so enthusiastic to push the volume up that they're apt to over modulate. But the cause of the trouble could easily be in the links, radio or cable, between studios and transmitters. Anyhow, as I mentioned before, many French listeners are so dissatisfied with the quality that f.m. receivers are much less common than had been expected.

### TV Hazards

UNTIL a doctor friend showed me a recent issue of *The Lancet* I'd no idea that watching the TV screen could be so hazardous an occupation! It appears, though, that prolonged viewing from a chair of the wrong height, or lounging in an easy chair as you watch can bring on pains in the neck and cause damage to veins and arteries. I'll admit that certain items can themselves be pains in the neck—or would be if you were compelled to watch them. There are about half-a-dozen other dire perils to the human frame included in the article. But I was relieved to read they are not serious threats provided that you don't view to excess, wear tight garments or sit in slouchy attitudes. Anyhow, I shall use my set as hitherto and risk it.

## DECADES OF EXPERIENCE



## PLUGS AND JACKS



List No. J.36



List No. J.2



List No. J.35

A small selection from our comprehensive range of jacks, suitable for the connection of equipments such as :-

loudspeakers, microphones, light telephones, tape recorders and speech/sound apparatus. Conforming to B.S.666.



List No. P.215



List No. P.538/Chrome

List No. P.539/Gold Plated



List No. P.38

Three general purpose jack-plugs conforming to B.S.666., P.538 is designed for use with screened concentric or

axial cable. All types may be ordered to :- 6.0 mm Ø size for use with continental equipment.



A. F. BULGIN & CO. LTD., BYE-PASS ROAD, BARKING, ESSEX  
Telephone: R1Ppleway 5588 (12 lines)

## Why Electron?

IN many textbooks on elementary electricity and magnetism we are told that when the ancient Greeks rubbed a piece of what they called electron, they found it produced what we today call electrostatic effects. From other sources we learn that two thousand years later Dr. William Gilbert, of Colchester, demonstrated this effect to Queen Elizabeth I by rubbing a piece of amber on her silk stockings.

Now this explanation is all right as far as it goes but the trouble is that it does not go far enough. None of the textbooks, as far as I am aware, go on to explain that long before Thales, of Miletus, discovered the electrostatic properties of amber, it had been given the name of electron because it had been observed that it exhibited what we today would call electromagnetic properties. In short, it was called electron because it exhibited electrical properties; and the contrary, that the electrical properties it exhibited were so-called because its name happened to be electron is *not* true.

Before you all seize your pens and bottles of H<sub>2</sub>SO<sub>4</sub> to write vitriolic letters to the Editor saying "Free Grid must go," I would ask your indulgence while I amplify my remarks. Most authorities are agreed that amber was first brought to Greece by foreign traders, most probably the Phœnicians who would naturally have their own name for it. Since they spoke a Semitic tongue it wouldn't surprise me if it bore some slight resemblance to our own word amber which is also of Semitic origin, being a corrupted form of the Arabic word anbar.

Probably the Greeks would simply have Hellenicised the Phœnician name but they noticed that it had the same property of "glittering" or reflecting light as was possessed

by other substances they already had, namely gold, silver and certain alloys which had already been given the generic name of electrons simply because they glittered or, as we should say, reflected or re-radiated electromagnetic waves in a certain band of the spectrum which we call light waves.

To get at the exact meaning of the word electron we split it up into its component parts elec-tron, the first part being part of the Greek word elector meaning dazzling (and umpteen synonyms). The suffix "tron," as we were told years ago in the pages of *Wireless World* by the late L. H. Bainbridge-Bell\*, means the agency by which a thing is brought about. In English, except in the case of thermionic valve nomenclature, we write "tron" as "tre" as in theatre, which simply means a place which enables us to view (a play, etc.).

\* Letter to the Editor, April 1947.

## Is History Bunk?

NOWADAYS it has become fashionable to believe that it was the Duke of Richmond rather than Richard III who caused Edward V and his brother to be bumped off. This is very confusing to those of us who were brought up to regard wicked Uncle Richard as a nepoticide. We can't do much about all this confusion but what I think we can do is to be sure that we get our own contemporary history correct so that our descendants don't have to unlearn what they will be taught at school about things which happen in our time.

I am, of course, thinking more of the history of radio than of anything else because I recently read some startling statements about the history of the B.B.C. which ought not to go unchallenged. Recently a well-known journal has been serializing the life of Gordon Selfridge, the founder of what used to be called "a certain Oxford Street store" in the days when the B.B.C.'s 2LO transmitter was housed there.

The historian said in one of the instalments that the transfer of the 2LO transmitter from Marconi House to Selfridge's was effected and a more powerful transmitter built because of the coming into use of more and more valve receivers. The logic of this argument is so fatuous that I won't deal with it further except to say that the real reason for the transfer was that it was desired to increase

power in order to extend the range of the transmitter. This could not be done at Marconi House without causing further interference with the Air Ministry receivers nearby. Also, of course, the aerial on the roof of Marconi House and the transmitter in the building were only lent by Marconi's.

## Learned Lucubrations

OUR sister journal, until December 1959, *Electronic & Radio Engineer*, and now *Electronic Technology*, has had a career rather like that of a Hollywood star in the matter of nominal inconstancy, but it has never divorced itself from any of the principles with which it started its career in October, 1923, under the title of *Experimental Wireless*. Indeed, so far from any question of divorce arising in its career, it was quite early (September, 1924) joined in marriage with another journal, *Wireless Engineer* which, as in the case of many marriages, eventually ceased to be the nominal junior partner.

I well recollect discussing with the late P. K. Turner, at one time editor of the journal, the merits of a new tuning unit which had been marketed for the purpose of enabling a simple broadcasting receiver to be built with the minimum of trouble. A set was built with this unit, and details published in *Wireless World* (July 1st, 1925), the designer being a very august member of the world of wireless who preferred to hide his light under a bushel by adopting the pseudonym of Wilson.

I had expressed approval of the tuning unit on the grounds that it was neat and compact, in striking contrast to the mass of straggling wires and plug-in coils which were the curse of sets of those days. P. K. Turner treated my remarks with withering scorn on the ground that I had not measured the r.f. resistance of the coil and, therefore, was not in a position to express an opinion in favour of the tuning unit or otherwise.

However, as I told him, he and his journal were as far removed from the everyday world of the average none-too-technical set constructor and broadcast listener as a racing car enthusiast from the ordinary motorist. Yet, of course, were it not for the efforts of the racing motorist, and the mathematics with which the pages of *Electronic Technology* are bespattered by the backroom boys in their learned lucubrations we should never be able to enjoy the comforts of our family cars and domestic sound and television receivers.

Dr. Gilbert demonstrates

